

Sound & Vibration Analysis System
O-Solution DS-5000

ONOSOKKI

The partner of your measurement
The partner of your discovery





Sound and vibration measurement

It has a long process to get to know its physical phenomena.
Determine the measurement environment, selecting the sensor,
setting for measurement and analysis,
and comparison...

Ono Sokki's Sound and Vibration Analysis System is
sure to break down the feeling that
makes you hesitate.

Quickly, easily, at anywhere with high accuracy measurement
This is the development ideas of our new designed system.

The partner of your measurement
The partner of your discovery



O-Solution



DS-5000

One click and smooth mode switching Measurement ↔ Analysis

The O-Solution has "Measurement mode" and "Analysis mode" in one application. You can quickly check the result in analysis mode after the measurement.

Measurement mode



Connect to the DS-5000 to record the time-series data of sound and vibration, and perform the frequency analysis and tracking analysis in real time. Useful for measurement for

- Natural frequency using a shaker or impulse hammer
- Rotating equipment, etc.



Go further analysis
instant!



Go higher precise
measurement

Analysis mode



You can edit and analyze the recorded time series data. Flexibly layout of large volumes of time series data or data with different formats; simultaneous display or overlapping them. Useful for more detailed analysis or analysis of transient phenomena.



Flexible screen layout

The docking window allows to change the display position of windows to your preferred layout.

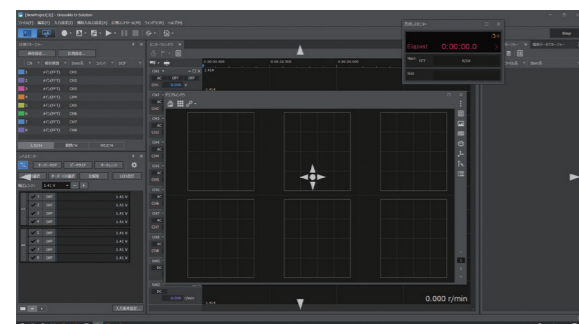

Easy data management

O-Solution collectively manages measurement and analysis conditions and acquired data in a project. It can list the data list with the data manager and compare multiple conditions and channels by the search/sort functions.

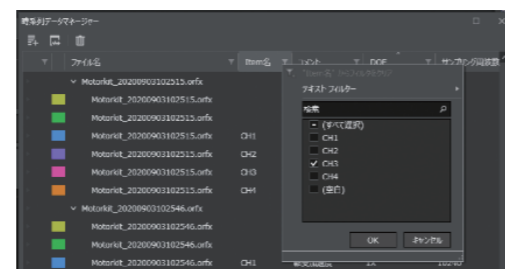

Features

Measurement mode



Quickly grasp the measurement status

A monitor window that displays the time waveform (10 seconds) allows you to set and measure while observing the time waveform.



Simultaneous dual analysis

Simultaneous analysis while recording allows you to work in a minimum time.

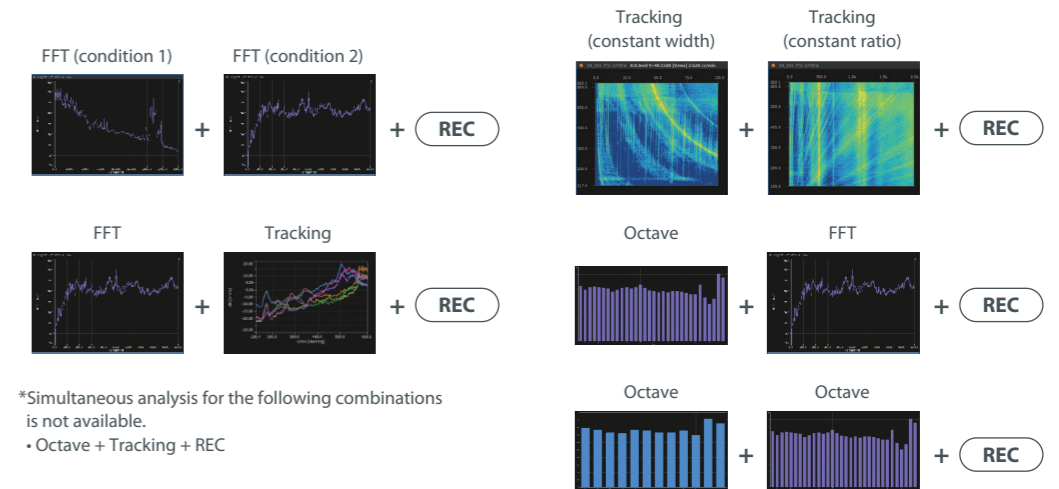

*Simultaneous analysis for the following combinations is not available.
• Octave + Tracking + REC

Analysis mode



Easy grasping of physical phenomena

Simultaneously displaying, displaying side-by-side and overlapping the data in different physical quantities (vibration, revolution speed, torque, temperature, etc.), format, and sampling frequency.

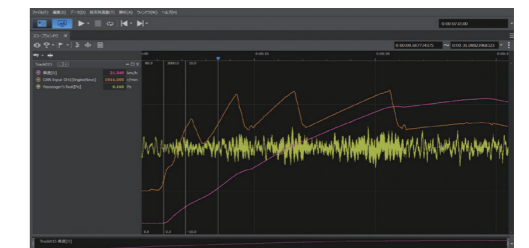
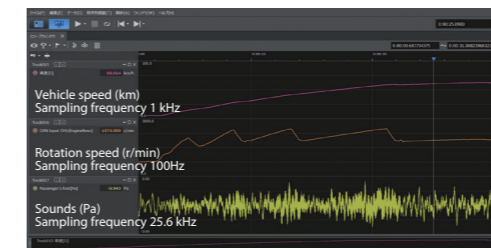

Compatible with formats of each logger manufacturers



*.mem



*.gbd



*.hdr

ASC II Wave MDF UFF



→ O-Solution

Data of different physical quantities such as sound, vibration, torque, strain, rotation, etc., and sampling frequencies (10 μHz to 100 GHz) can be displayed simultaneously or overlaid.

O-Solution Functions

The O-Solution is based on the OS-5100 platform, and optional functions can be added according to the application. The viewer function O-Solution Lite is license-free and anyone can use it.

Viewer	Basic functions	Options			
O-Solution Lite	Platform OS-5100	Digital Filter Function OS-0521	Sound Quality Evaluation Function OS-0525	Sound Power Level Using Sound Pressure OS-0541	External Control Function OS-0510
		FFT Analysis Function OS-0522	Fluctuation Sound Analysis Function OS-0526	Information Technology Equipment Option OS-0542	Hardware Connecting Function OS-0512
		Tracking Analysis Function OS-0523	Time Frequency Analysis Function OS-0527		
		Octave Analysis Function OS-0524	Statistical Analysis Function OS-0531		
			Video Playback Function OS-0532		

Viewer : O-Solution Lite

Easily check the results remotely

The O-Solution Lite has a license-free viewer function that anyone can use and it can playback audio and display analysis data. You can complete the measurement at site effectively to share the test results and analysis. With the DS-5000, recording of time waveforms is available. The installation of O-Solution is required in advance.

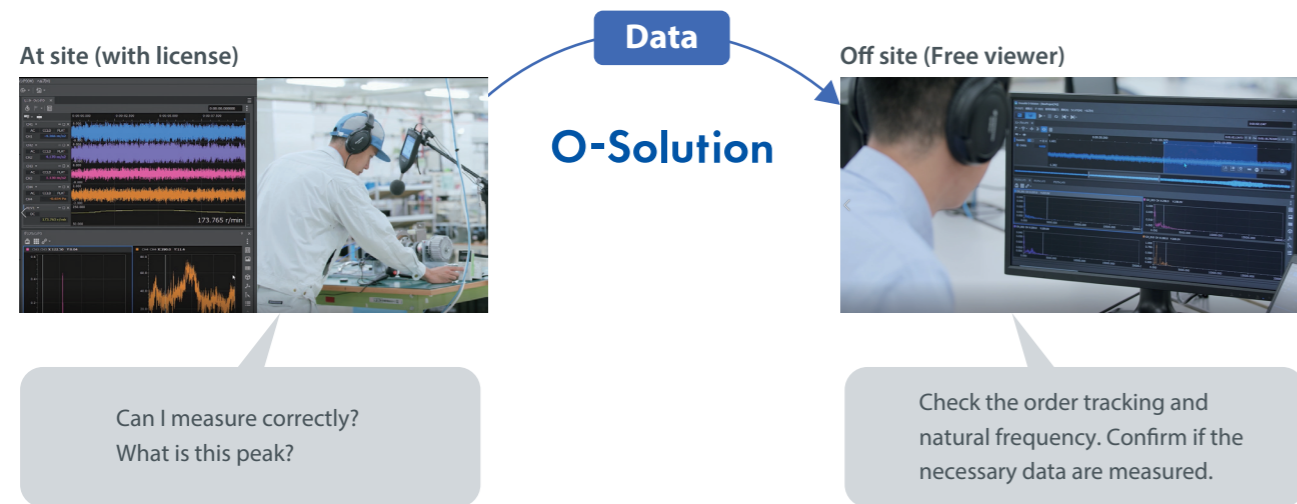

By combining O-Solution Lite and DS-5000, the time waveform can be recorded. It enables to import binary data from each logger and convert it to CSV data.



Platform : OS-5100

Fulfilled functions lead to efficient performance

All the processing tools before the measurement and analysis are included. A variety of editing functions such as waveform cutting, correction, and search is available.

Time axis preprocessing

This function performs arithmetic processing such as a filter on the time waveform after AD conversion. No need a filter amplifier separately.

Digital filter	LPF, HPF, BPF, A-weighting, C-weighting • LPF, HPF, and BPF are all sixth-order Butterworth filters. BPF is also a sixth-order filter coefficient and therefore the slope becomes -18 dB/oct instead of -36 dB/oct.
Absolute value	Supported
Time axis calculus	1st derivative, 2nd derivative, single integral, double integral
DC removal before integration	Supported

Replay analysis

In the measurement mode, you can analyze the recorded time-series data while replaying it. It enables to perform preliminary analyses repeatedly before switching to the analysis mode, improving the efficiency of determining analysis conditions.

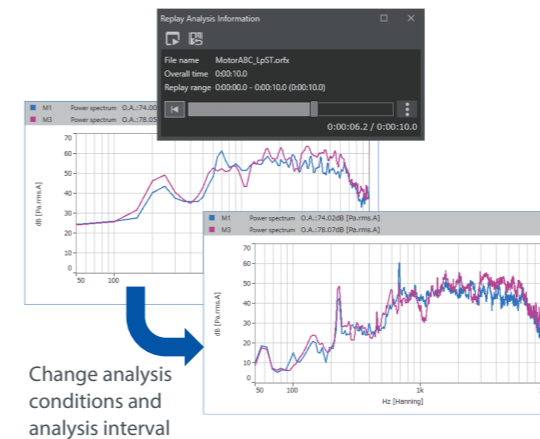

Automatic calibration function

The software automatically detects the calibration signal and performs the calibration. This reduces work time when calibrating multiple channels, etc.

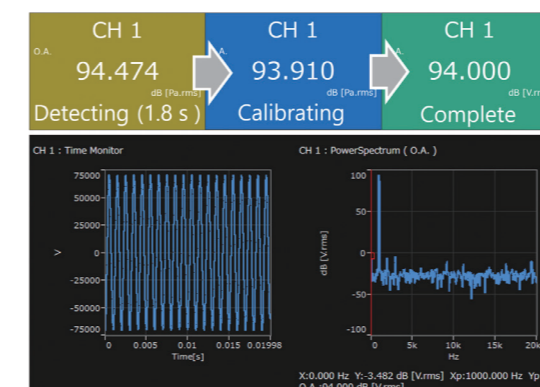

Trigger function

A variety of functions using a trigger signal are included, effective when the recording/measurement start or stop. The time monitor and the time waveform for one-shot of FFT analysis are displayed in a setting screen, and it allows intuitive trigger setting.

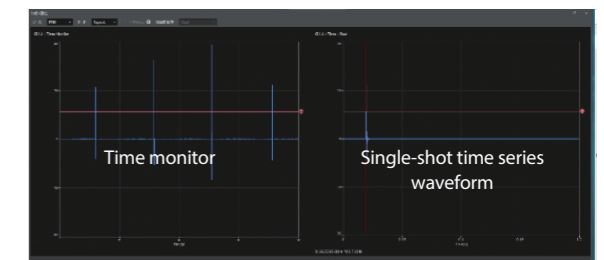

Source	(Measurement) Internal, external, level (Analysis) Item
Mode	Repeat, OneShot
Operation	Start, Stop, Start & stop
Other functions	<ul style="list-style-type: none"> • Double hammer cancel • Average Undo • Prerecording • Data can be acquired using the trigger function during recording • Display function (time monitor and time waveform)

Numerical value enlarged

The measurement values are displayed larger, making it easy to check the numbers even on-site.

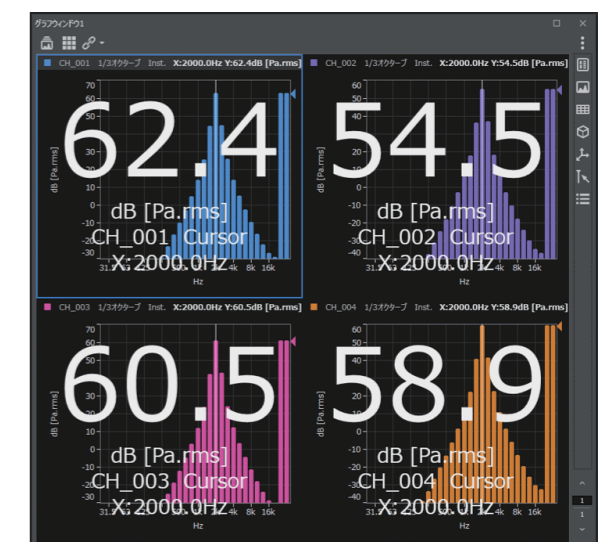

O-Solution Functions

Platform : OS-5100

Enhance test efficiency under predefined measurement conditions

It enables efficient operation when there are multiple predefined measurement conditions such as standard tests.

Quick Access Window

Frequently used operations such as starting a trigger and starting measurements can be displayed on the screen as large shortcut buttons. By customizing them for standard tests in automotive driving tests and on-site measurements, operability is improved. Buttons can also be registered as keyboard shortcut keys. In addition, if the external control function (OS-0510) is installed, repetitive operations can be assigned to a single button.

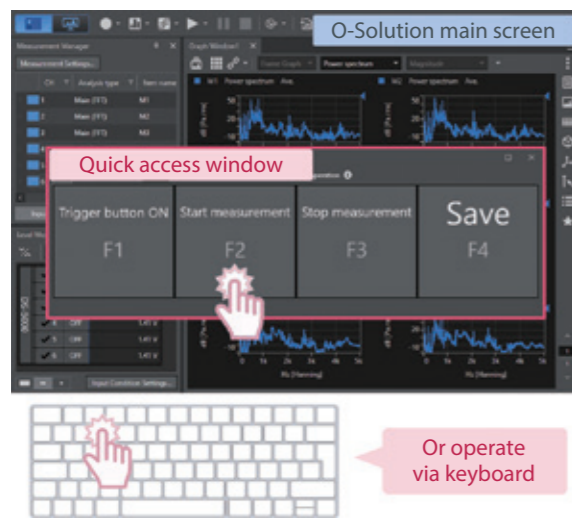

Measurement Condition List/Analysis Condition List

You can easily switch between pre-registered measurement conditions with a single click. This proves particularly useful when multiple predefined measurement methods exist, such as for standard tests. Switching between conditions without repeated input prevents setting errors and improves operational efficiency. Similarly, post-analysis processing conditions can be switched with a single click.

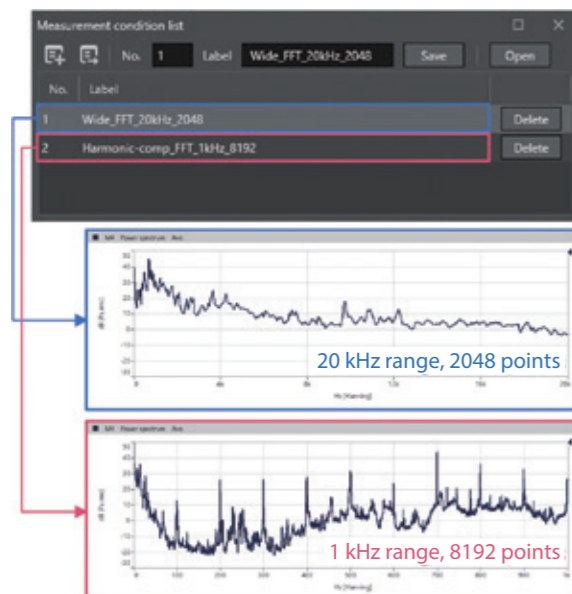

Add graph setting items to 'Favourites'

The O-Solution offers various setting items, such as the spectrum format and unit conversion on the graph display. Frequently used settings can be saved as Favourites. By grouping commonly used settings for the standard test, you can improve the efficiency of your analysis work.

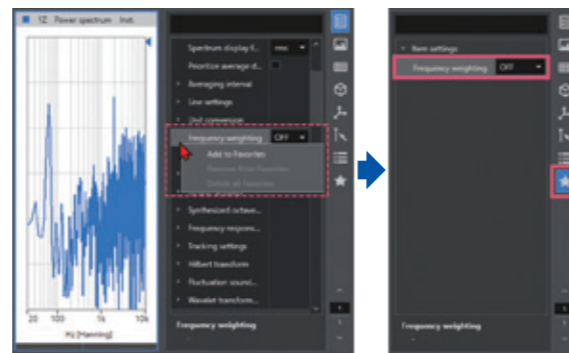

File Editing (Merge mode)

You may select any channel from multiple recorded data and merge them into a single file. It enables to efficiently carry out tasks such as comparing sounds or analysing data.

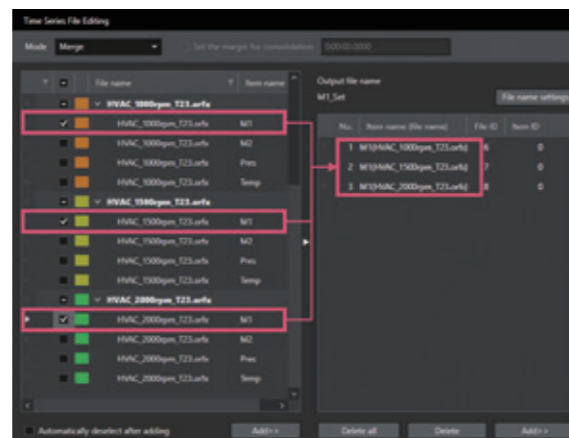

Importer

You can choose to copy the time series data files into your project file, or to reference them without copying them. Referencing method will reduce time to import the files and also the size of your project files.

For example, 96ch, file with 10 minutes of recording time

Importing method	Importing time
Copying to a project	296 sec
Without copying (referencing)	120 sec*

* For orfx files only.
* If the path of the referencing file changed, reimporting is required.

Platform : OS-5100

Load time waveform file instantly and quickly grasp characteristic points

In the analysis mode, the O-Solution has the function that can read the time waveform in a short time.

Import project files created by the OS-2000 series

In automotive development, the OS-2000 series has been used for data verification tasks on measurement and control benches, enabling the comparison of multiple time-series data. The O-Solution allows the direct import of vast measurement data from within the OS-2000 series projects (supporting only the restoration of time-series waveforms). Even if only project file data created in the OS-2000 series remains without the raw data, the O-Solution can restore the data, enabling smooth management and verification of historical data.

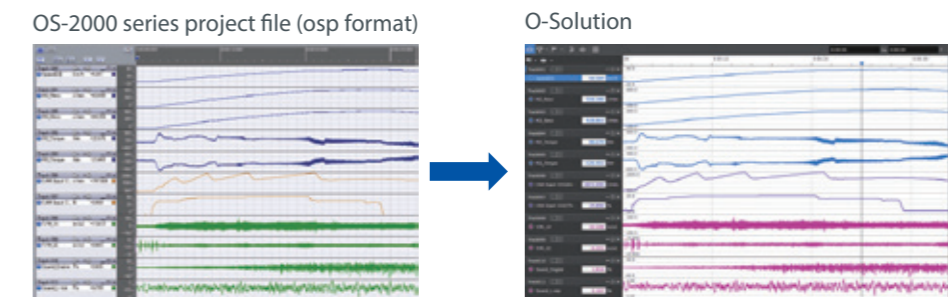

Statistics window

It calculates statistical values from the time waveform. In the measurement mode, statistics (maximum value, skewness, etc.) are displayed from time waveforms acquired in real time. In analysis mode, the statistical values for any interval are displayed and characteristic points such as maxima and local maxima are displayed while moving a cursor. In addition, the statistical trend calculation function can display changes in statistical values over time, making it easy to find points of change in data recorded over a long period of time.

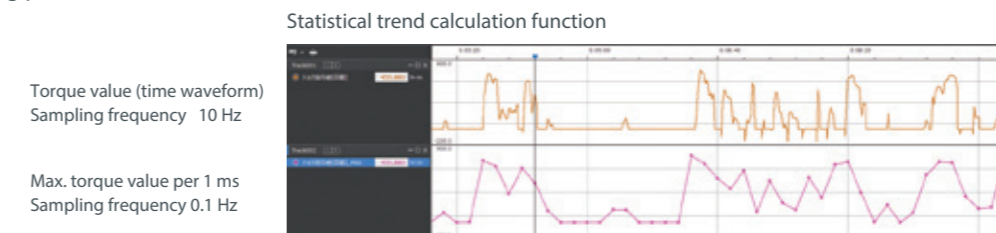

Options

Digital filter function : OS-0521

Find quickly the frequency band of the noise

You can quickly find the frequency band that causes noise or vibration by applying an IIR or FIR filter to the recorded data and listening to the sound. The filter applied time series data can be saved as another file.

To apply filter to the order and frequency at the same time is useful for investigating abnormal noises in rotating object.

FIR filter

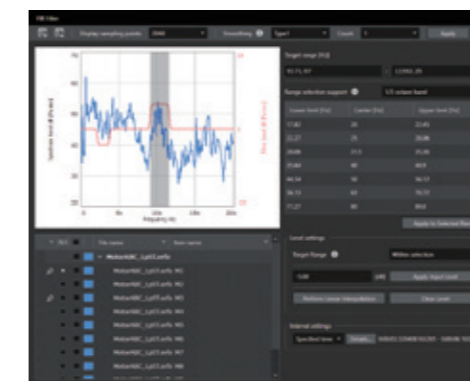

IIR filter

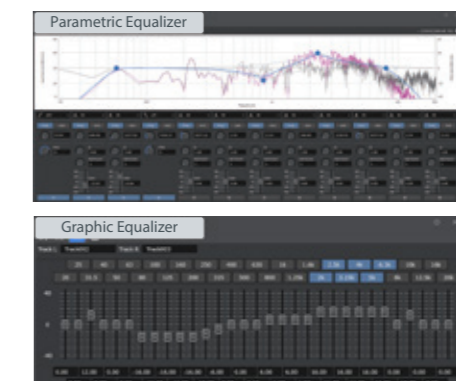

O-Solution Functions

FFT analysis function : OS-0522

Grasp the frequency components and resonance frequencies

The waveform on the time axis can be decomposed into frequency components, which allows to observe the magnitude and resonance phenomena of vibration and sound in detail. It is equipped with basic calculation functions such as power spectrum, frequency response function, coherence function, and damping ratio.

Along with FFT analysis, octave analysis and tracking analysis can be measured in real time.

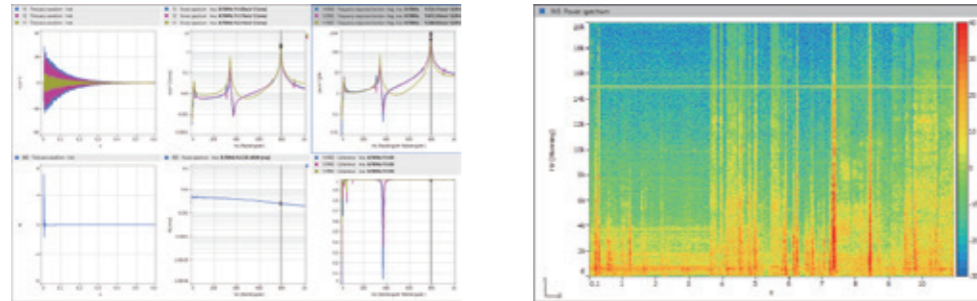

Check amplitude values such as acceleration, displacement and velocity (Tripartite graph)

It enables to show the tripartite graph*. Three amplitude values (acceleration (m/s²), velocity (m/s) and displacement (m)) at any arbitrary frequency can be read simultaneously in real time. It is useful for evaluating floor vibration where precision equipment is installed.

By displaying VC curves**2, allowable vibration reference or setting environment evaluation of vibration sensitive instruments, such as semiconductor manufacturing equipment, AFMs, electronic microscopes, and laser interferometers is able to be judged quickly.

Measurement example: Floor vibration in an acoustic building (anechoic chamber)

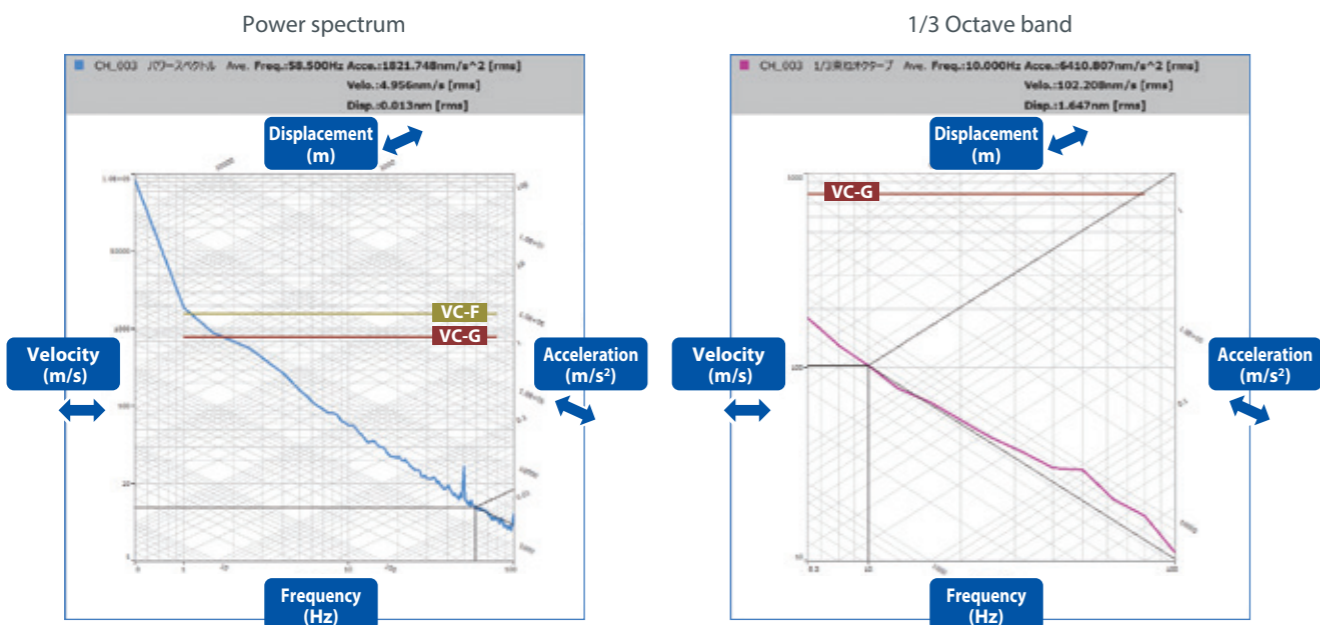

*1 The tripartite graph enables you to read amplitude values of acceleration (m/s²) and displacement (m) which is based on velocity (m/s), on the frequency (Hz) axis.
 **2 The VC curves (Vibration Criterion Curves) are proposed as a guidelines for allowable micro-vibrations when installing precision equipment such as semiconductor manufacturing equipment and electron microscopes. It is used in 1/3 octave bandwidth evaluation. The criteria is divided into 7 levels every 6 dB (VC-A, VC-B, VC-C, VC-D, VC-E, VC-F, VC-G) and used as a guideline for applications such as optical microscopes or laser devices with long optical path.

Tracking analysis function : OS-0523

Understand the sound and vibration characteristics of rotating object

You can understand the sound and vibration generated by rotating objects such as motors and generators, and at which rotation speed each order component becomes large.

Tracking analysis with constant ratio and constant width, and offset tracking is also available.

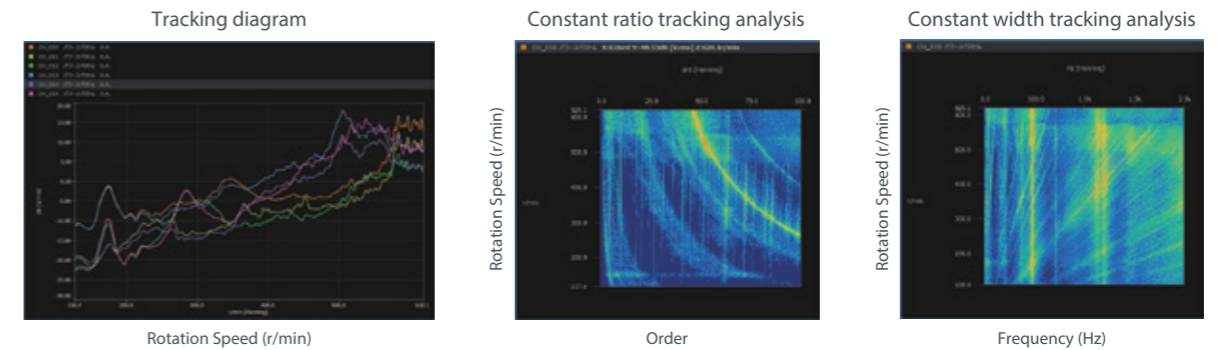

Confirm the order trend of a rotating machine even without sweep operation

Tracking analysis data can be created by combining multiple data measured at constant rotation speeds (Data integration based on revolution speed). Even if it is not sweep operation, you can efficiently specify the problematic orders over the range of rotational speed by sequentially measuring every constant rotation speed.

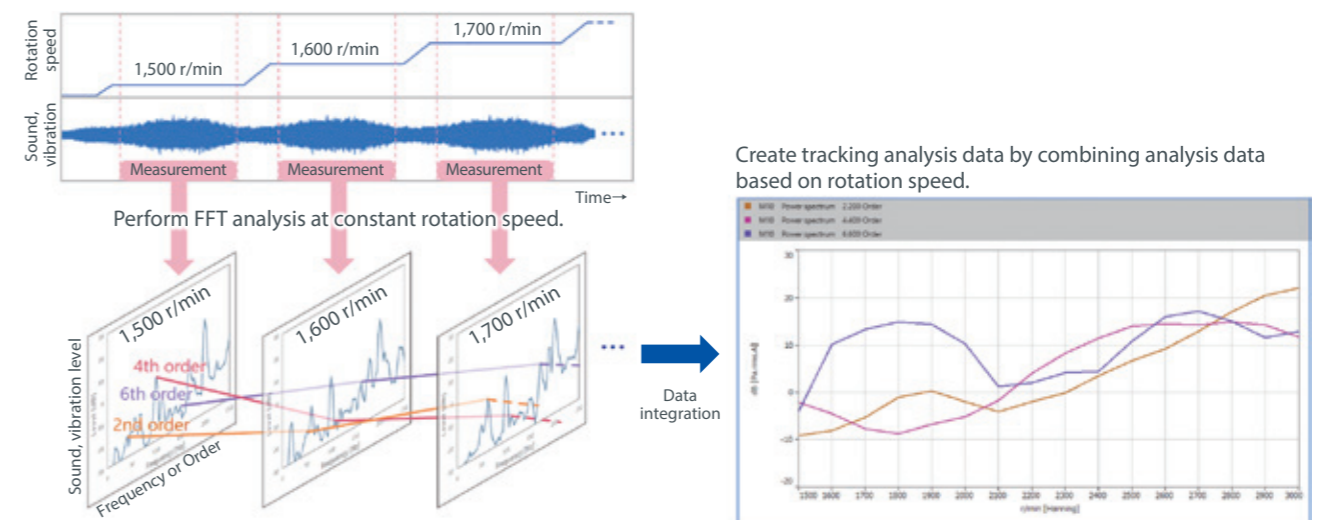

Octave analysis function : OS-0524

Measure environmental noise and vibration

The octave analysis has similar characteristics to the human ear (logarithmic (Log) to frequency). Often used to understand noise and vibration levels and to perform measurements in accordance with ISO and JIS standards.

Along with FFT analysis, 1/N octave analysis or multiple analysis can be measured in real time.

Further, 1/1, 1/3, 1/6, 1/12 and 1/24 octave analysis are also available in real time measurement.

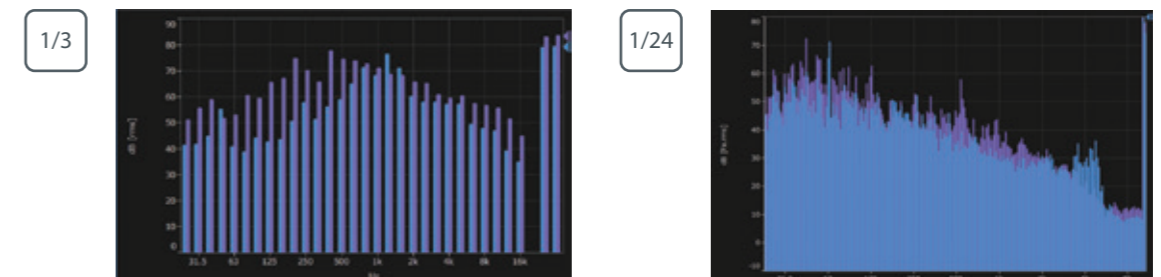

O-Solution Functions

Sound quality evaluation function : OS-0525

Sound quality evaluation considering human hearing characteristics

The general sound analyzes such as FFT analysis and 1/3 octave analysis may not quantify human auditory impressions. Thus, even two sounds with different listening impressions may not show any difference in the analysis results. This function enables to obtain sound quality evaluation indicators that take into consideration the human hearing characteristics and correspond to various sensations of sound and can quantify the amount of sensation such as "loudness", "pitch of sound" and "roughness".

Sound quality evaluation indicators

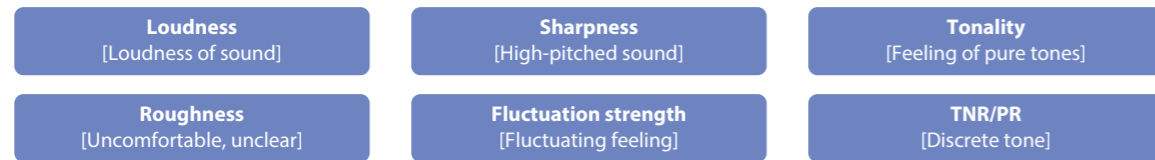

Applicable standard

- Loudness for stationary sounds (ISO532-1)
- Loudness for non-stationary sounds (ISO532-1)
- TNR/PR (ISO7779 Annex D)

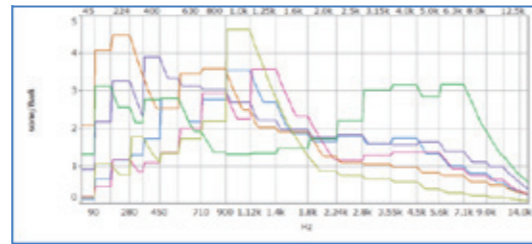

Example of Sound quality evaluation- Comparison of mechanical sounds

The following graph shows the example of analysis to 6 mechanical sounds which has different sound volume each. The upper green line, the result analyzed with the evaluation quantity "A-weighting sound pressure level", shows same values for all 6 sounds. On the other hand, the lower pink line, the result analyzed with "Loudness", shows all 6 sounds have different values. When hearing these 6 sounds actually, we recognize that each sound has different sound volume, just like the result of Loudness. By using Loudness, the difference of sound volume when human really hears, which cannot be evaluated based on sound pressure including A-weighting sound pressure level, can be evaluated.

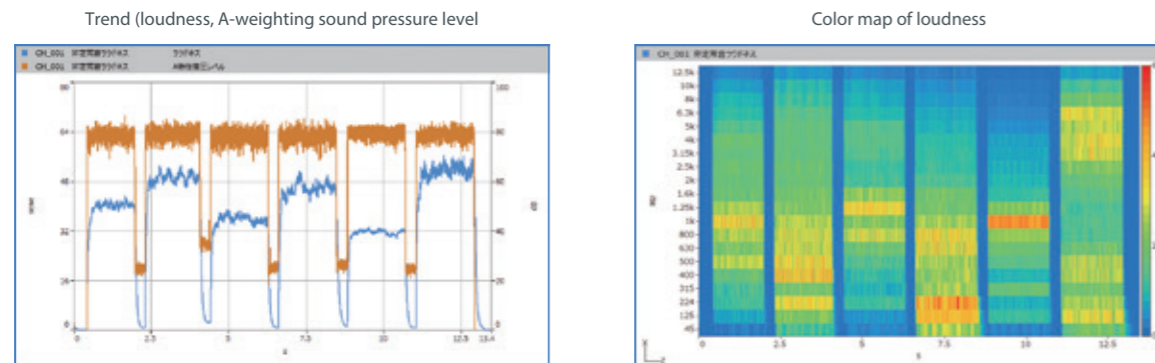

What is Loudness?

Loudness refers to the amount of sensation (total amount of excitation of the auditory nerves) that is felt subjectively by individuals. The loudness of a pure tone of 1 kHz and 40 dB is defined as 1, and the loudness of other sounds is expressed as multiples of this. The unit is sone.

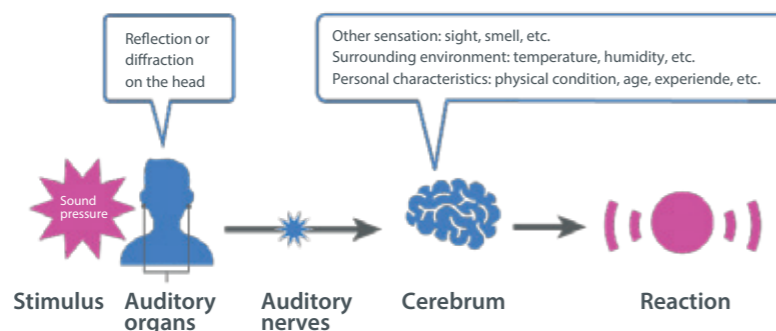

Fluctuation sound analysis function : OS-0526

Analyze fluctuating feeling of sound

Fluctuation sound analysis can quantify the magnitude of various fluctuation components based on loudness, and extract fluctuation components of sounds that are difficult to detect in FFT analysis, such as rattling and buzzing sounds, even if they are small. It enables to check the detailed fluctuation components analyzed into the pitch of the fluctuating sound and the fluctuation speed.

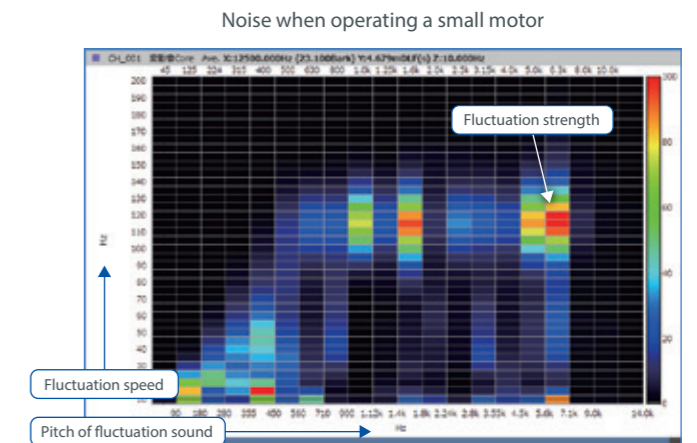

Fluctuation sound simulator

With the fluctuation sound simulator, the analysis result can be evaluated to adjust the fluctuation components while eliminating only annoying fluctuation components or amplifying only easy-to hear ones.

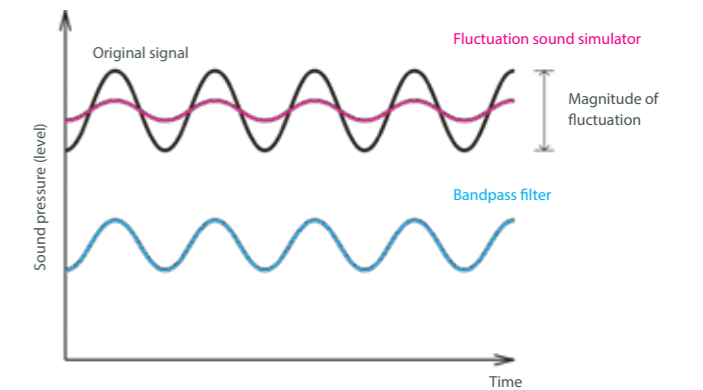

Analysis example: Abnormal sound from a small motor

A person listened to the operating noise from a small motor and made a pass/fail judgment. Even in cases where it is difficult to capture the abnormal noise with FFT analysis, fluctuation sound analysis makes it possible to clearly distinguish between non-defective and defective products.

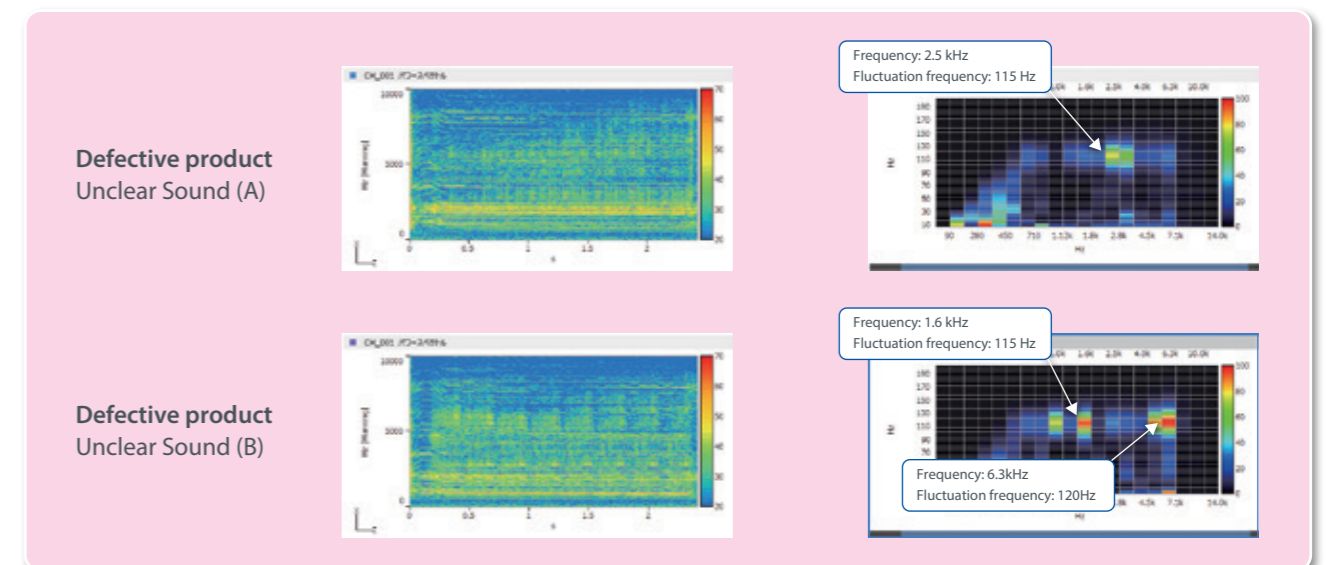
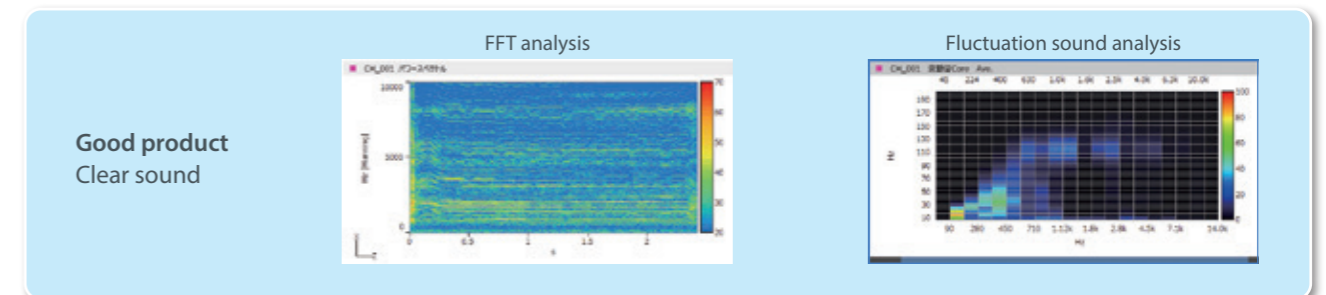

O-Solution Options

Time-frequency analysis function : OS-0527

Analyze transient phenomena

This function discovers the features which is difficult to catch by FFT analysis, and displays clearly time change of the frequency component while maintaining its frequency resolution. It is equipped with Short-time Fourier Transform and Wavelet Transform.

Short-time Fourier Transform

The STFT performs the Fourier transform to improve the time resolution while maintaining the required frequency resolution by setting the cut-out time window length and the Fourier transform length separately. This is an effective analysis method for observing spectral changes in a very short time.

Wavelet Transform

The Wavelet transform is an analysis method that enables simultaneous analysis of temporal fluctuation and spatial transition of complicated waveforms such as a sudden or non-stationary sound or vibration. The analysis time length is changed depending on the frequency in this method. It brings a good balance between time and frequency, so it is suitable for capturing the analysis result as a whole.

The graphs below show the results of FFT analysis, STFT and Wavelet transform of golf hitting sounds respectively.

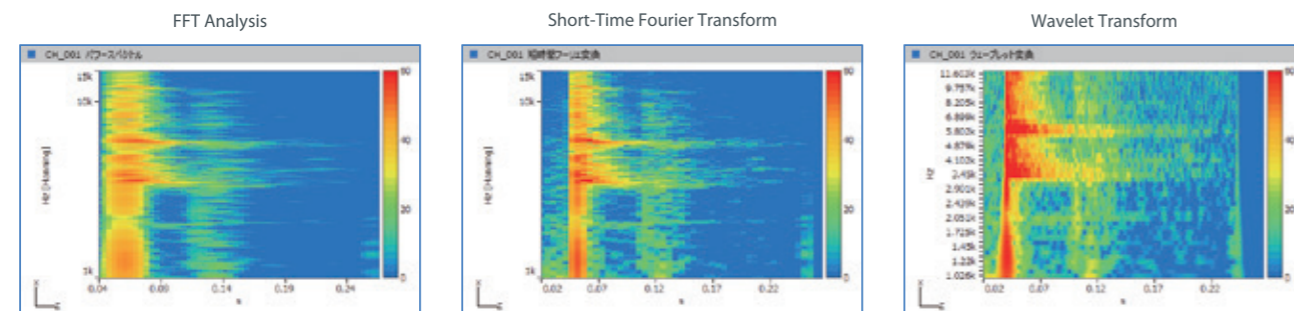

Statistical analysis function : OS-0531

Statistical analyses in one window

By performing bivariate analysis of the command value and feedback value for torque or rotation speed, you can find the correlation, slope, etc.

Basic statistical analysis

Histogram, autocorrelation function, normal probability plot

Bivariate analysis

Scatter plot, cross-correlation function, stereogram, interval statistics

3-variable analysis

3D scatter plot, 3D interval statistics

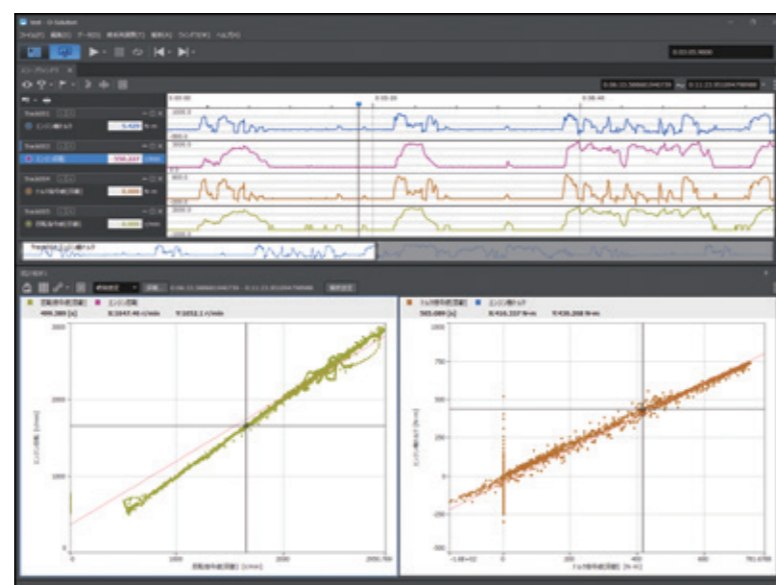

Video playback function : OS-0532

Understand phenomena by observing the behavior of the target object

Video files recorded with a video camera or smartphone can be loaded into the O-Solution and played back along with analysis results of sound, vibration, etc. By displaying video, time series data, FFT analysis results, etc. side by side, you can determine which part of the target object's behavior is causing a problem.

Furthermore, for example, audio data from smartphones sent by field workers can also be utilized for frequency analysis.

* Audio data obtained from smartphones cannot be calibrated or converted to accurate decibel (dB) values without calibration data. The amplitude values should be treated as reference values only.



Supported video file formats

AVI, MP4, MOV, WMV, M4A

* Video data can be rotated vertically or horizontally (fine adjustments are also possible).

* If the start positions of the data recorded with the DS-5000 and the video data are misaligned, you can align the positions of each data by using the time series position alignment function.

* For details regarding supported codecs, please refer to the specifications.

Hardware connecting function : OS-0512

Perform real-time analysis

By using the OS-0512 Hardware Connection Function, FFT analysis, tracking analysis, Octave analysis are available in the measurement mode.



External control function : OS-0510

Control the O-Solution from user's application Automate repetitive tasks For product inspection system

Using the library for external control function, O-Step API (C#) and its language extension function, O-Step API service (Python, MATLAB, LabVIEW, C++, VBA), the O-Solution can be controlled from the user's application. Sound and vibration data can be automatically imported into the user's system.

Example 1: Automatically measure, analyze and save huge data.
Example 2: Periodic and automatic NV evaluation of test equipment

Simple measurement based on International standards, Thorough analysis of problematic sounds



Due to the electrification of automobiles and the increasing efficiency of home appliances, the products that generate high frequency sounds have been increasing. Since high frequency sounds are directional, it is difficult to evaluate them based on the A-weighted sound pressure level at a single point. Therefore, it is more effective to use the sound power level which captures the emitted sounds across the entire surface. Sound power level is the total amount of sound energy emitted by a product, regardless of the listening position and is a global indicator used in environmental labels such as Eco Mark, the Blue Angel and noise regulations. The measurement method is determined by international standards. This system allows you to take efficient noise countermeasures by the measurements that comply with standards and easily confirming the frequency peaks and sound pressure distribution of problematic sounds.

Features

Conforming to the latest ISO standard: ISO 3744:2025

Performs measurements in accordance with standards and outputs reports in Excel format. The setting items of standards can be customized and are useful for calculating noise test codes.



Useful for cause analysis

- Analysis and recording simultaneously (Synchronous recording with other sensors is also available.)
- Calculate FFT, instantaneous sound power level.
- Sound pressure level distribution can be displayed.

After calculating the sound power level according to the standard, detailed analysis can be performed using the recorded data. It enables to calculate FFT and instantaneous sound power levels by post-analyzing and efficiently identify frequency peaks, timing, and sound source locations that cause increases in sound power levels. Saving the time of re-measurement leads to cost reduction of noise test.

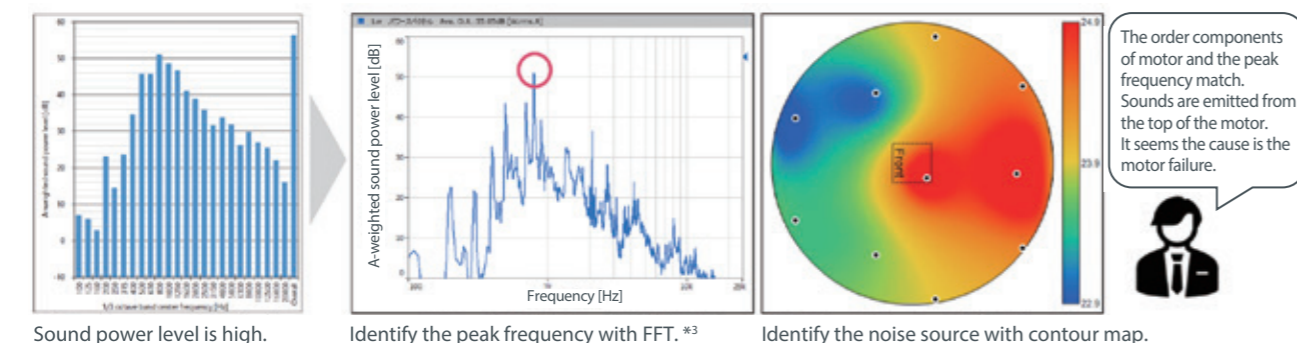

*1 Only available if the sound source has reproducibility and is stable.
 *2 Background noise correction and area correction are performed based on the standards, however, the calculated values are reference values as the calculations are performed at a frequency resolution or time resolution that is different from the standards.
 *3 When calculating sound power level with the frequency resolution of FFT, the FFT analysis function (OS-0522) is required separately.

Sound Power Level Using Sound Pressure: OS-0541

Conforming to standards applied to various objects

The sound power level has been specified in the standards so that it can be measured in a variety of environments without limiting the target object. The OS-0541 complies with the standard for measuring sound power level using sound pressure with a microphone. The OS-0524 Octave Analysis function is separately required.

Conforming to standards

Test environment	Standards	Number of measurement points
Anechoic room, semi-anechoic room	Precision method ISO 3745: 2012, JIS Z 8732: 2021	20 or more
Semi-anechoic room, outdoor	Engineering method ISO 3744: 2025, ISO 3744: 2010, JIS Z 8733: 2000	9, 10 or more
	Survey method ISO 3746: 2010	4 or more
Reverberation room	Precision method ISO 3741: 2010, JIS Z 8734: 2021 (only comparison method)	6 or more
High frequency sound power level	ISO 9295: 2015 (only when not including discrete tones)	Refer to ISO 3741, 3744

Sound power level measurement in semi-anechoic room

This is the most popular measurement method. Measurement is taken by arranging microphones on the surface of a hemisphere or rectangular parallelepiped surrounding the object.

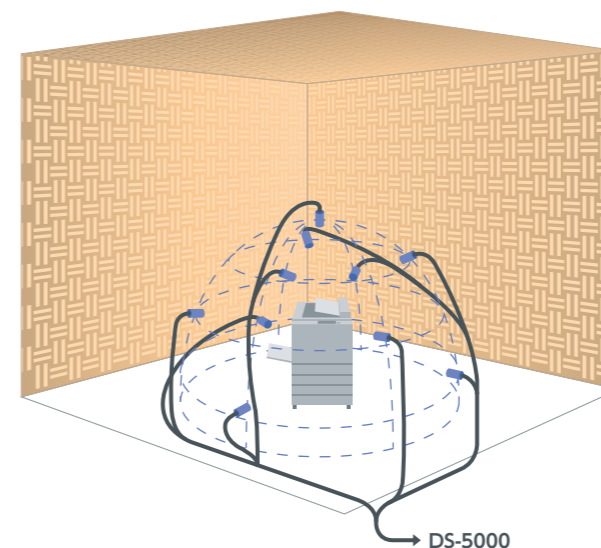

Sound power level measurement in reverberation room

Compared to a semi-anechoic room, more accurate measurements can be made with fewer measurement points. There are direct method and comparison method, and the OS-0541 only supports comparison method.

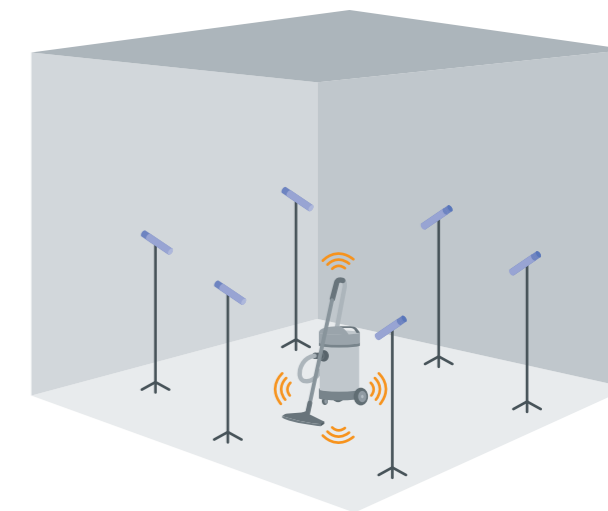

Information Technology Equipment Option: OS-0542

Conforming to standards applied to office equipment

The measurement of noise emitted by computers, printers, multifunction devices, etc. is specified in the standard ISO 7779. This standard is also applied in obtaining environmental labels. It calculates emission sound pressure level at defined operator or bystander position as well as sound power level and the prominent discrete tones.

Conforming to standards

Measurement items	Standards
Sound power level for information technology and telecommunications equipment	ISO 7779: 2018, JIS X 7779: 2012
Emission sound pressure level	ISO 11201: 2010
Declared noise emission values	ISO 9296: 2017
Prominent discrete tones	ISO 7779: 2018, JIS X 7779: 2012 Tone-to-Noise Ratio, Prominence Ratio

Measurement image (Emission sound pressure level at bystander position)

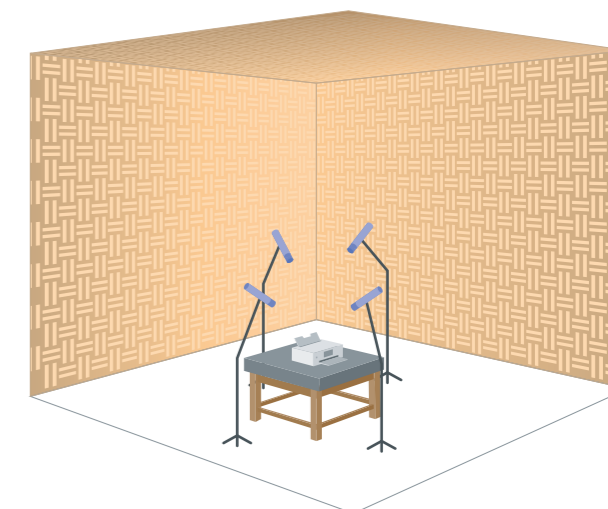

Sound power level measurement for air conditioners, home appliances, machinery, office equipment, etc.

By measuring according to standards, you can more accurately understand the overall sound of the product.

Condition of the measurement



Image of measurement result

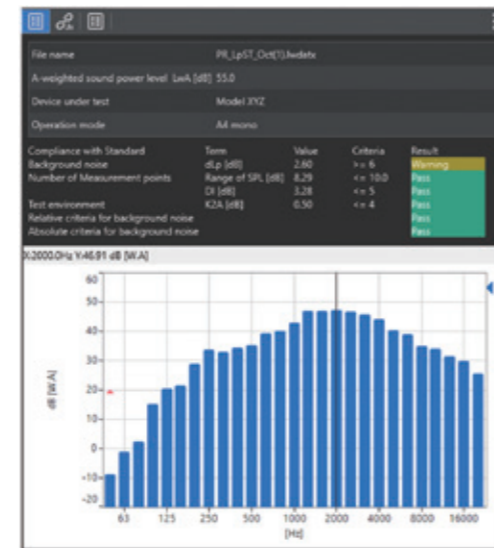

System configuration

It is a general measurement system with 10 microphones arranged on a hemispherical surface.

Model	Product name	Qty
DS-5100	Main unit	1
DS-0526	6ch 40 kHz Input unit	2
OS-5100	Platform	1
OS-0524	Octave Analysis Function	1
OS-0541	Sound Power Level Using Sound Pressure	1
OS-0542	Information Technology Equipment Option	1
OS-0512	Hardware Connecting Function	2
MI-1235	Measurement microphone	10
MI-3111	Microphone preamplifier	10
MI-0311	Extension rod	10
MX-2020	Signal cable for microphone (20 m)	10
SC-2600	Sound Calibrator	1

- A PC is required. Recommended specifications follow the O-Solution specifications.
- Microsoft® Excel 2016, 2019 or Office 365 is required to display reports.
- Microphone stands are required to fix microphones.
- System assembly fee is required when setting the measurement environment, such as selecting a microphone stand, etc.

Gear box driving noise reduction

By checking the sound pressure level distribution at the same time as the sound power level, you can efficiently identify the noise source and confirm the effectiveness of countermeasures.

Measurement of sound power level

Reduction of sound power level requires to take measure to the peak of 5 kHz.

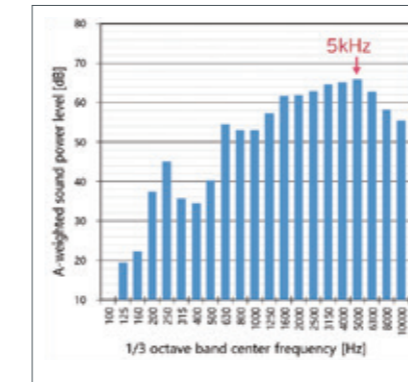

Measurement results of sound power level

Cause analysis

Noise emission from near the shaft
 → Found that there was some rattling in the shaft.

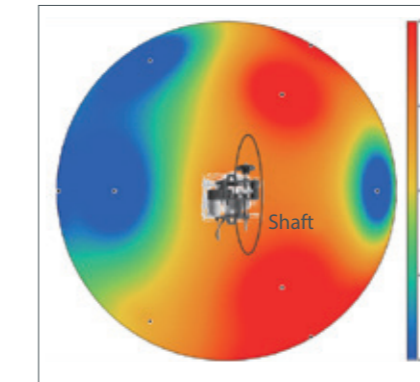

Sound pressure level distribution (5 kHz)

Before/after measures

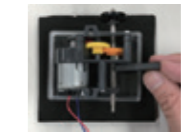

Cushioning with rubber material eliminates shaft rattling
 → Reduces sound power level (2 dB)

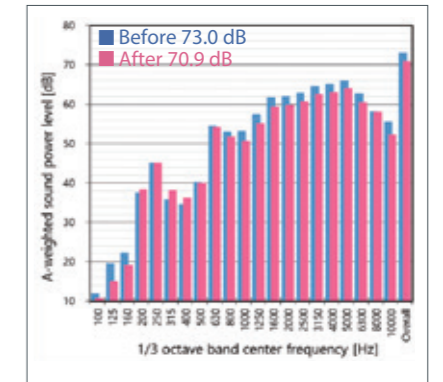

Comparison before/after measures

Sound power level of rotating equipment

Equipment with built-in motors tend to generate high-frequency sounds due to their rotational speed. High frequency sounds may sometimes be unpleasant, thus it is important to reduce them. The OS-0541 allows you to post-analyze the measurement data and to calculate the sound power level in the range of tracking analysis. By understanding the overall sound power level according to the rotation speed, you can clarify the operating conditions that require countermeasures. The OS-0523 Tracking Analysis function is required separately.

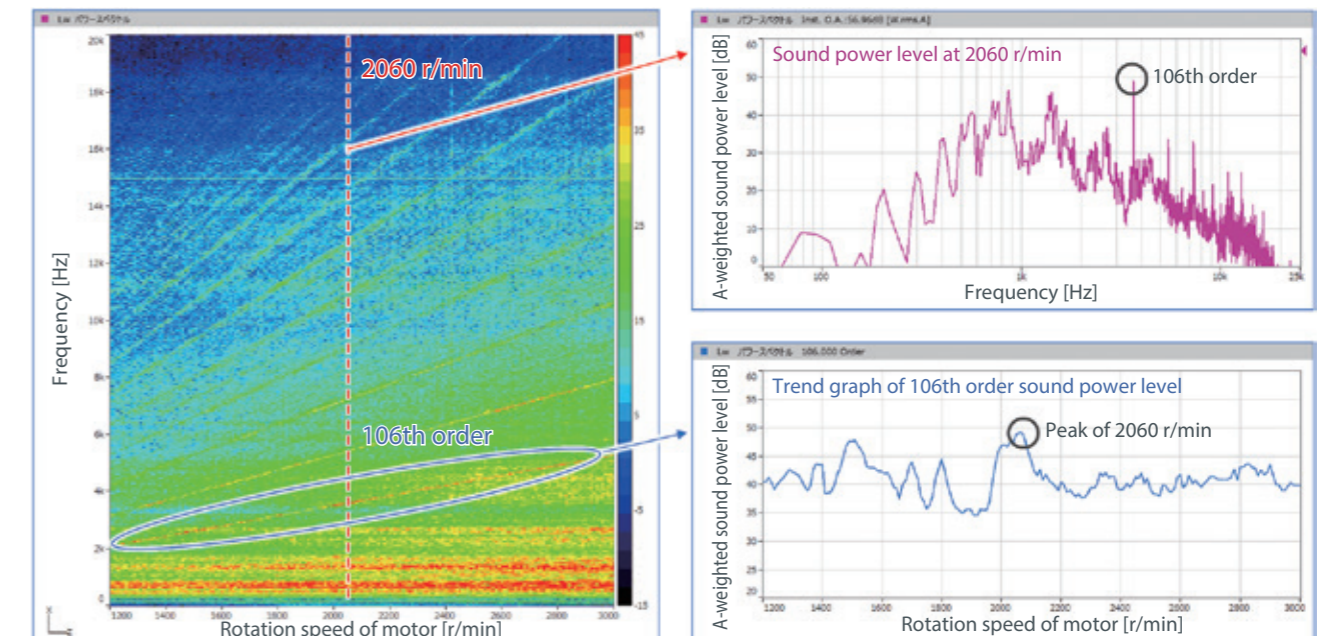

Understand sound power levels throughout the rotation range

OS-4100 Frequency response measurement software

Measuring the frequency characteristics (frequency response function) of mechanical structures and control circuits

The OS-4000 is dedicated software that can measure the frequency characteristic of various objects with high precision and high speed, such as vibration characteristics of mechanical structures, acoustic characteristics of speakers, motor control characteristics, servo analysis, coupling response characteristics, and battery impedance characteristics.

Measurement items :

Vibration, acoustic, servo, response, AC impedance characteristics

Measured targets :

Motors, drivers, piezoelectric devices, speakers, couplings, batteries

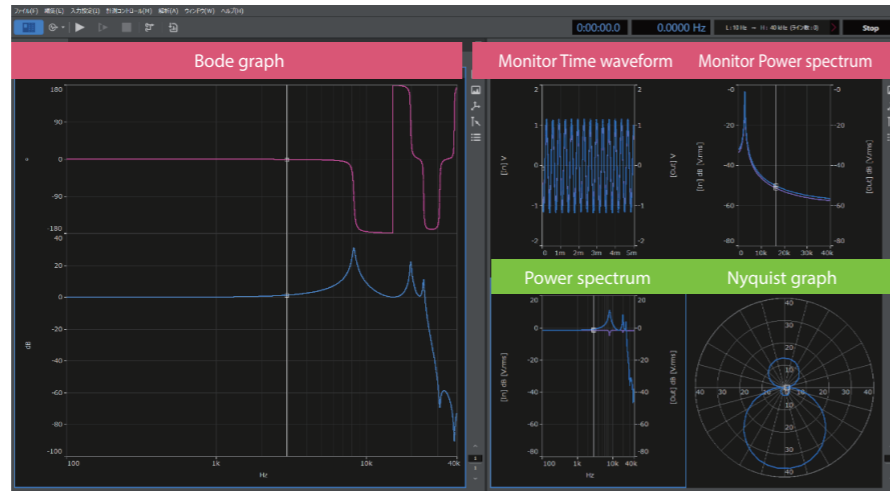
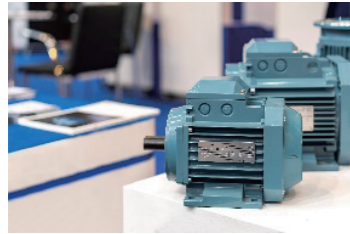

High accuracy

The performance of the hardware has been improved so that frequency response function can be measured with high resolution and precision.

[Comparison of dynamic range]

	FRA method	FFT method
DS-5000 :	160 dB	130 dB
DS-3000 :	140 dB	110 dB

Each channel is isolated. You can measure safely even in places where there is noise or potential difference.

Various graph displays

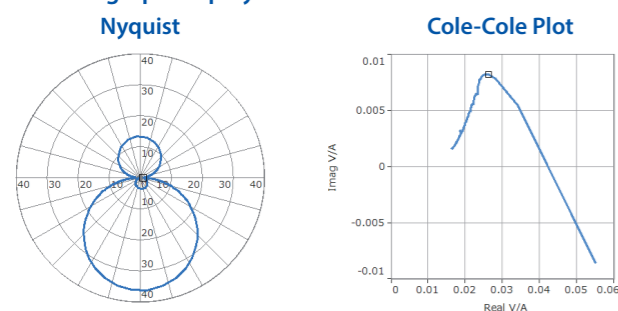

Nyquist, Co-quad, Nichols, Cole-Cole plot and power spectrum can be displayed.

Monitor functions

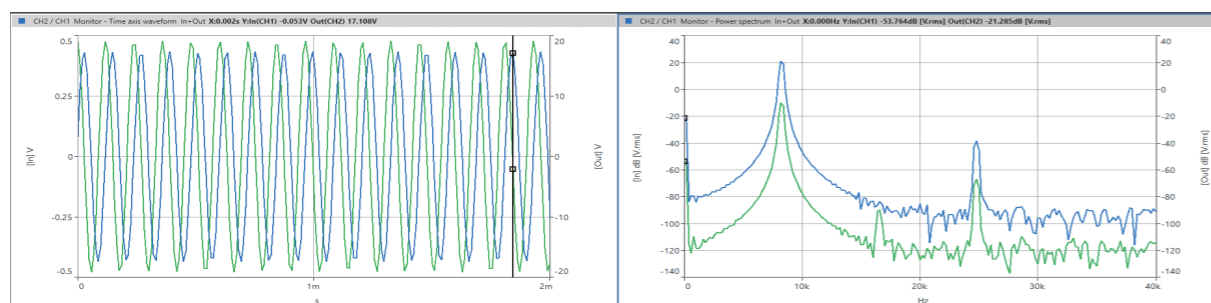

The time waveform and its instantaneous spectrum while measurement can be monitored, and the connection method or abnormality of data can be checked in real-time.

Reduction in calculation time of FRA method

Reviewing the existing calculation method and realizing a great reduction in measurement time

[Comparison of measurement time]

	Measurement condition	Measurement condition
OS-4100 :	54 second	100 second
DS-0342 :	195 second	365 second

Measurement condition ① : 1 Hz to 1,000 Hz 50 Line/Decade
Measurement condition ② : 1 Hz to 100 Hz 100 Line/Decade

Useful list functions

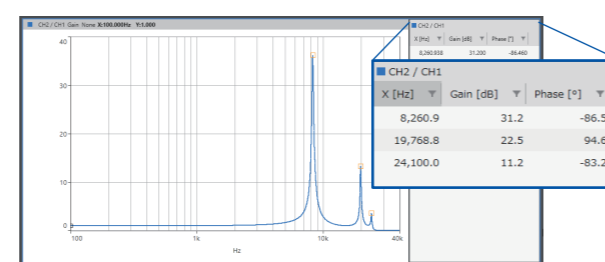

Listing up peak points and damping factor, auto search of gain margin and phase margin

Features

Two types of calculation methods

FRA method (Frequency Response Analyzer)

Obtains gain and phase for each signal frequency. This method is used for high accuracy and high dynamic range measurement.

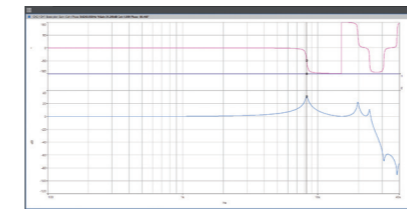

- Signal output: Log sine sweep
- Frequency resolution: 200 Lines/Decade (100 Hz to 40 kHz)
- Measurement time: 78 seconds (Averaging count 2 times/Line)

FFT method (Fast Fourier Transform)

Obtains gain and phase over a wide frequency range at high speed. This method can quickly grasp the frequency characteristics.

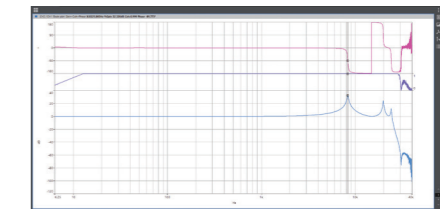

- Signal output: Random
- Frequency resolution: 6.25 Hz (6400 Lines)
- Measurement time: 17 seconds (Averaging count 100 times)

Step response function

The performance of the object can be obtained from the temporal response. By applying step signals to the object and measuring the step response signals, it automatically calculates the values related to response performance (rising time, etc.) and compares actual measurement data with past data.

Measurement image of Step response function

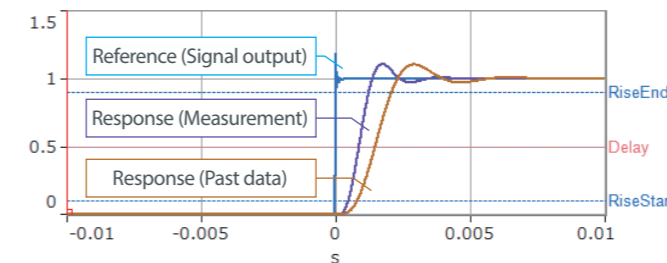

Auto calculation values

	Measurement	Import
Rise time [ms]	0.771	1.279
Delay time [ms]	0.879	1.484
Excess (overshoot) time [ms]	1.768	2.920
Overshoot [%]	10.755	10.343
Stabilization time [ms]	3.105	5.166
Logarithmic damping factor	2.556	2.470
Damping ratio	0.377	0.366
Oscillatory cycle [ms]	2.109	3.574
Attenuating frequency [Hz]	474.074	279.781

Data manager

The data manager enables to collectively manage acquired data, compare multiple data in the list, search/sort functions.

Analysis data manager

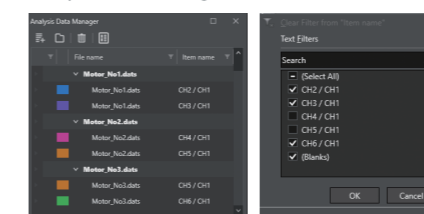

Supporting many types of files

You can export measurement data in the universal UFF and DATS (HDF5) formats which are compatible with the experimental modal analysis software, and import the files from the related products such as the O-Solution.

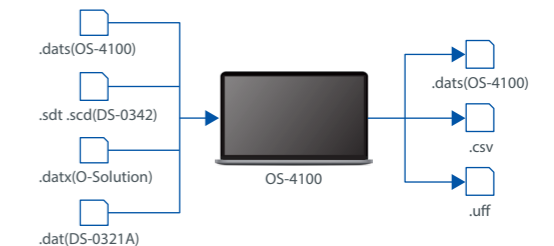

OS-0410 External control (Option)

Use in production lines, automation of measurements

It has the External control function as an option which can communicate with the user's application via TCP/IP, measure under measurement conditions prepared in advance and save.



- Automated inspection process for mass-production Automate each operation such as setting, measuring and saving with one button
- Control measurement instruments from other apps Control the measurement start/end timing and specify the measurement conditions.

OS-0410 External control

LAN port	For control side and communication (No required when operating within a PC)
Protocol	TCP/IP
Character code	ASCII
Line feed code	CRLF

Loss Factor Calculation Tool : OT-0450 (Option)

If the damping material alone cannot maintain the shape, or if the loss factor is large, it may be attached to a base material (with rigid, such as iron) for measurement.

This option allows to calculate the loss factor and longitudinal modulus of elasticity (Young's modulus) of a damping material itself from the measurement results of a multi-layered test piece (a material attached to a base or a base sandwiched with materials) measured using the frequency response measurement software (OS-4100).

Additionally, if tests are performed at different temperatures, the results measured at multiple temperatures can be overlaid.

Image of measurement results

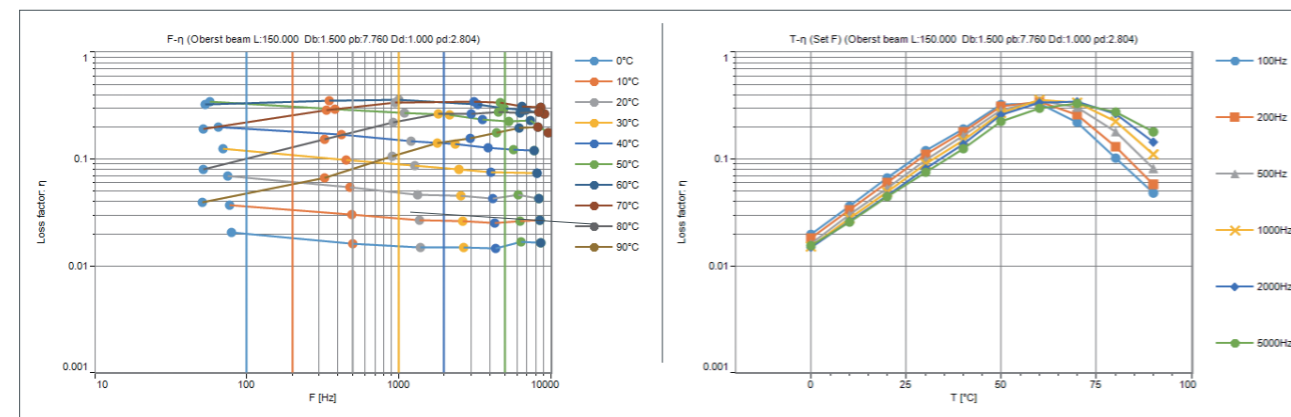

Loss factor of damping material alone

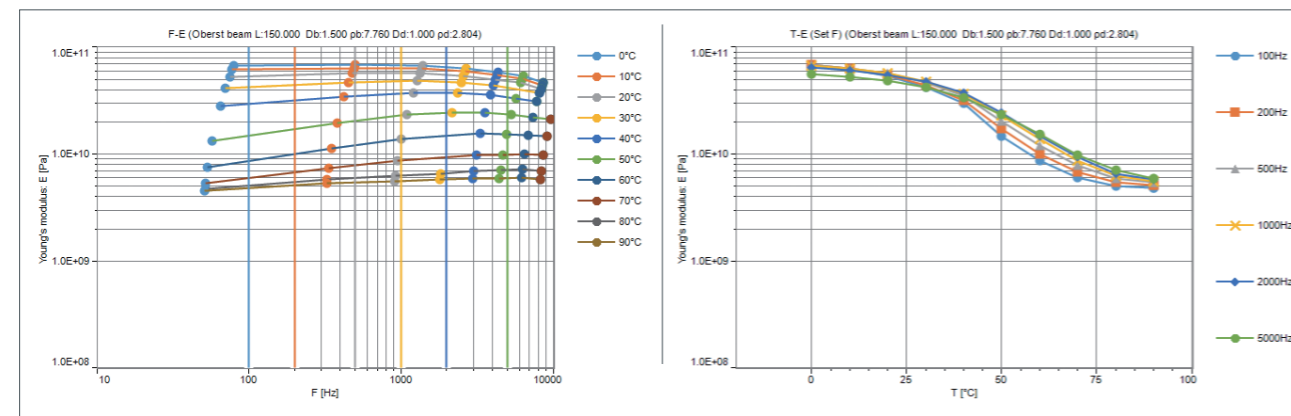

Young's modulus of damping material alone

Measurement of loss factor for damping materials

The "damping" is reducing the level of vibration on the surface of solid to convert vibration energy into thermal energy. The loss factor is one of indices for evaluating damping materials with such properties. There is the standard for measurement method, JIS K7391 in Japan. The loss factor is calculated by the half power bandwidth method from the peak of the frequency response function (impedance or mobility) obtained by forcibly vibrating a rectangular test piece. In the central exciting method, the calculation function and calculus function of the OS-4100 enables to calculate the frequency response (speed/force) after subtracting the weight of the contact tip. Then, the loss factor can be calculated from the peak of the frequency response function.

Measurement system

Cantilever method

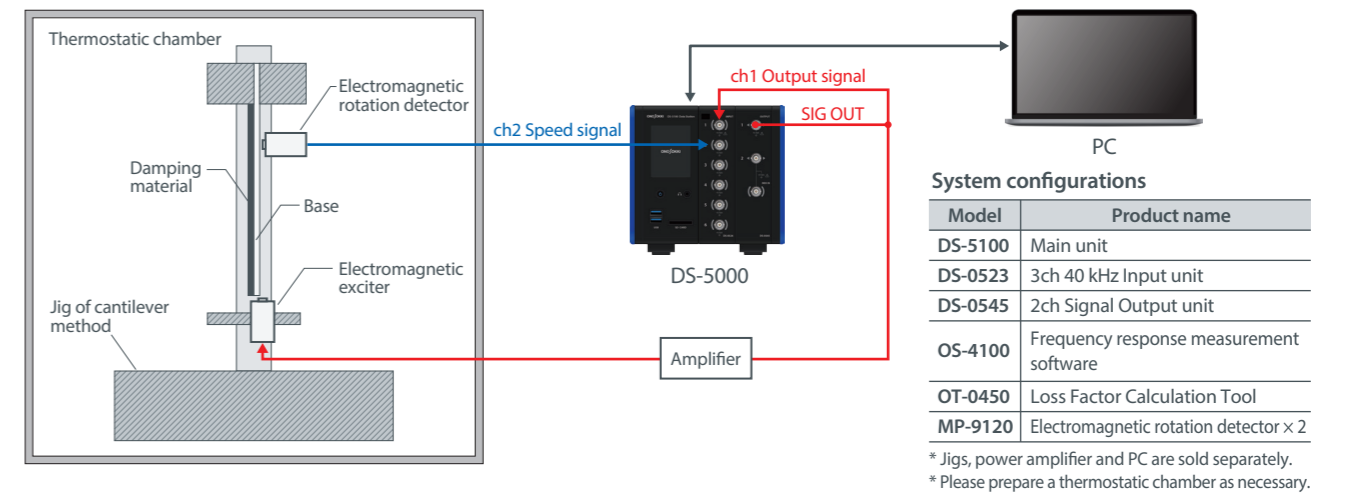

Central exciting method

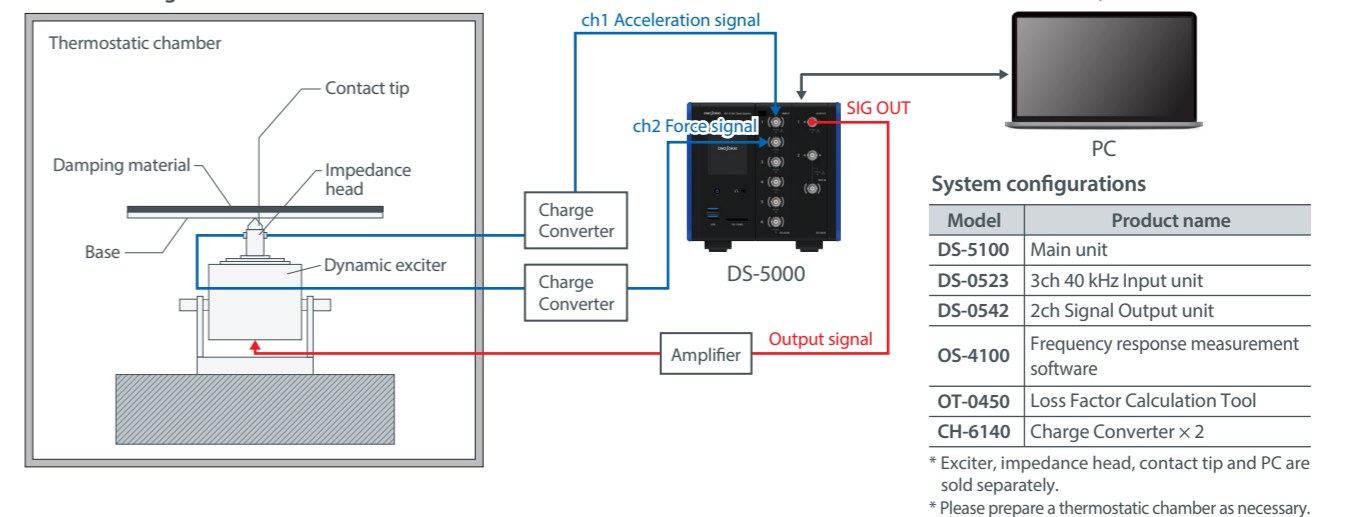

Image of test piece

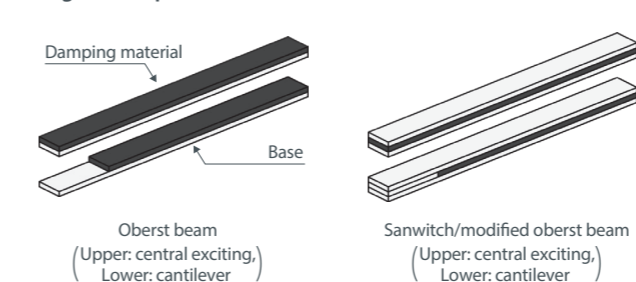
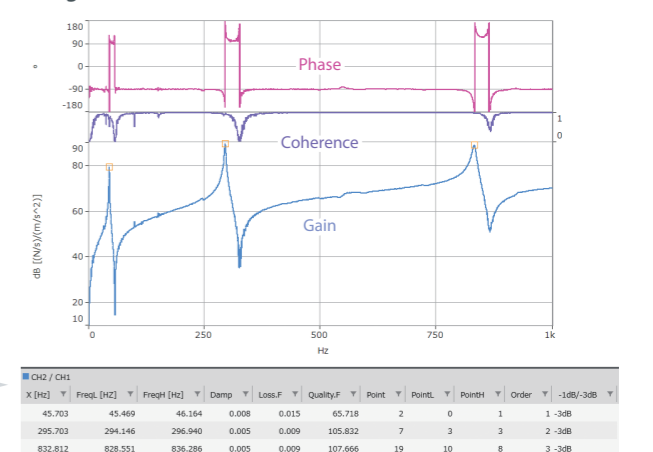

Image of measurement results



Along with checking the waveform of the frequency response function, you can check the loss factor for each order and the number of data points within the half power bandwidth, which is a guideline for the loss factor calculation accuracy.

Evaluation of vibration characteristics using an exciter

When vibration is applied to a structure, if that vibration frequency is equal or close to the structure's natural frequency, resonance will occur, resulting in extremely large vibrations that may lead to failure or destruction. Therefore, it is important to evaluate the vibration characteristics of structures. The OS-4100 can simultaneously measure up to 42 channels of vibration characteristics using an exciter. It can convert acceleration to displacement by the calculus function, control the amplitude value of excitation by the amplitude control function, and measure the characteristics after subtracting the weight of the jig (mass cancellation) by the four arithmetic operation function.

Measurement system

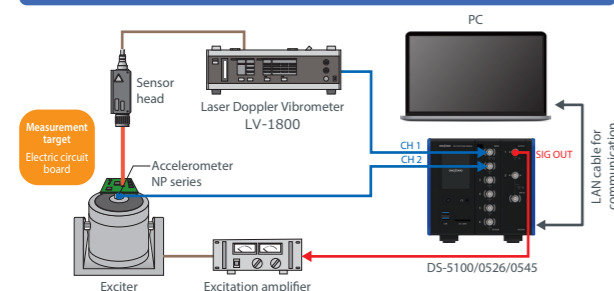
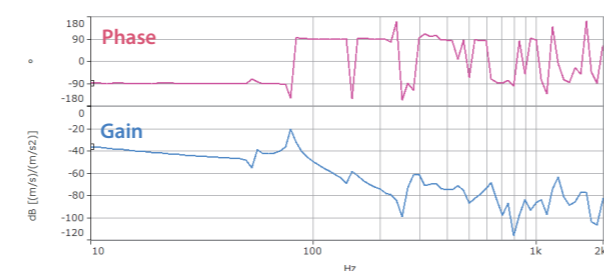

Image of measurement results

Output Amplitude Control function
Control the amplitude of the measured channel.



Laser Doppler Vibrometer LV-1800



Detection frequency range	0.3 Hz to 3 MHz (fc=-3 dB)
Maximum detection velocity	10 m/s (0-p), 20 m/s (p-p)
Minimum velocity resolution	0.3 μm/s or less (at 0.01 (m/s)/V)
Laser safety class	Class 2

Evaluation of control and response characteristic for motors or drivers

Motors and drivers incorporated in various products such as robots, conveyance equipment, semiconductor manufacturing machines, and automobiles have control circuits built in to control their rotational speed and torque. As the stability evaluation of control characteristic, there are gain margin and phase margin measurements. The OS-4100 can automatically calculate gain margin and phase margin from frequency response function (open loop transfer function). It can obtain the open loop transfer function by measuring the closed loop transfer function. The DS-0545 2ch Signal Output Unit outputs the signal that the signal generated from the DS is added to the feedback signal from the object, which makes it possible to directly input signals to the control circuit and easily evaluate the stability of the control circuit. In addition, by using the step response function it measures and automatically calculates responsiveness (delay time, overshoot value, etc.) in the time domain.

Measurement system

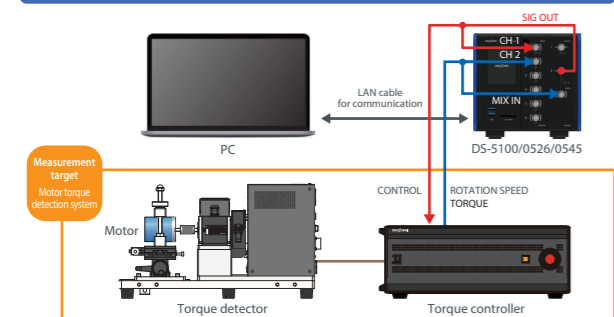

Block diagram

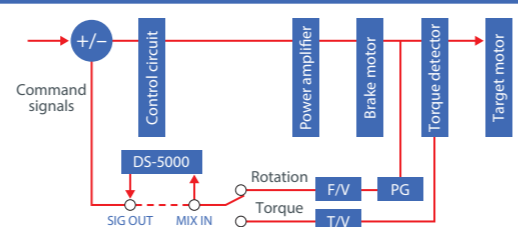

By using the summation function, the measurement signal can be added directly to the feedback signal, allowing you to measure the open-loop transfer function of the object.

Image of measurement results

Auto-search for gain margin and phase margin

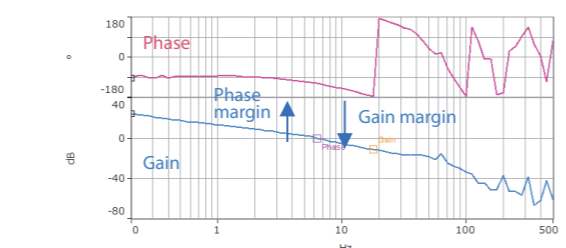

DS-0545 2ch Signal Output Unit (with Summation function)

The DS-0545 2ch Signal Output Unit outputs the signal that the signal generated from the DS is added to the feedback signal from the object. Noise immunity is improved as there is no need for preparing a summing amplifier and cables to/from the amplifier.

Evaluation of speaker acoustic characteristics

Sound frequency characteristics is one of the factors that evaluate speaker performance. By connecting the signal output from the DS-5000 to the speaker amplifier and capturing the sound generated from the speaker with a sound level meter or microphone, the OS-4100 measures the frequency characteristics of the speaker. Also, the function (cutoff search function) which finds a cutoff frequency automatically is equipped. Furthermore, two types of calculation methods are installed. The FRA method can be used to obtain data for each frequency with high accuracy, and the FFT method can be used to instantly obtain the characteristics of all frequency bands to be measured.

Measurement system

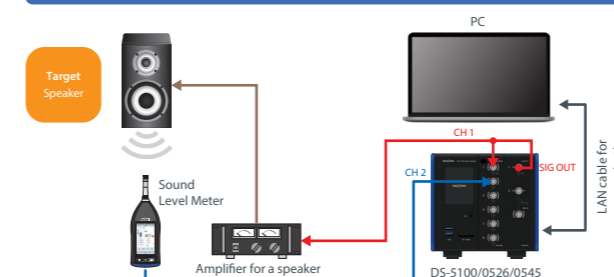
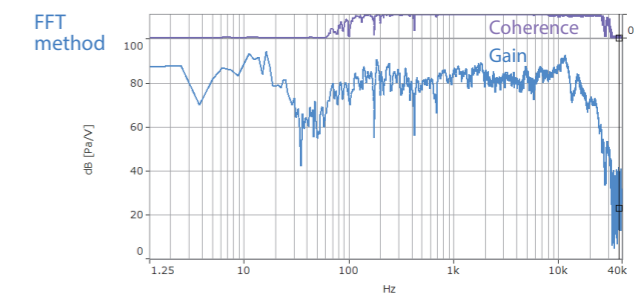
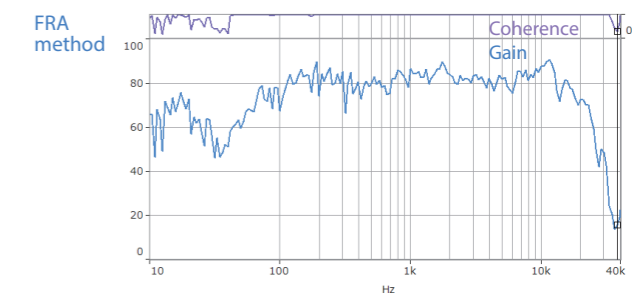

Image of measurement results



High performance Sound Level Meter LA-7700

Measurement frequency range	10 Hz to 20 kHz
Measurement level range	20 to 128 dB (A-weighting)
Self-noise level	12 dB or less (A-weighting)



Measurement of AC impedance of battery

One of the methods for evaluating batteries is the AC impedance method. This method enables to evaluate battery resistance characteristics (deterioration of electrodes, etc.) without destroying or disassembling the battery. The AC impedance can be measured by applying an AC current load to the battery and measuring the voltage and current of the battery. By adopting the FRA method, it is possible to measure with high accuracy and high frequency resolution in a wide dynamic range. It can display with a Cole-Cole plot, which is useful for estimating the cause of battery deterioration. uff file or HDF5 format is available for easy transfer of measurement results to simulation software.

* An electronic load device and a current probe are required for this measurement.

Measurement system

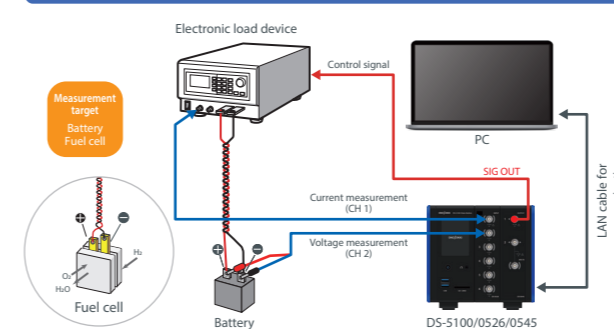
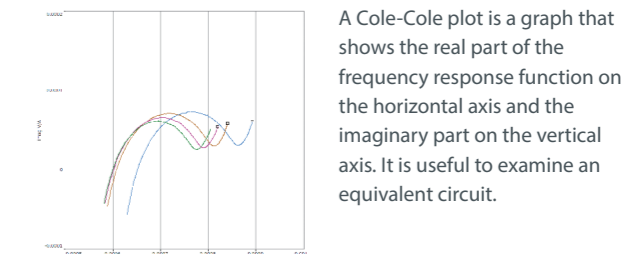
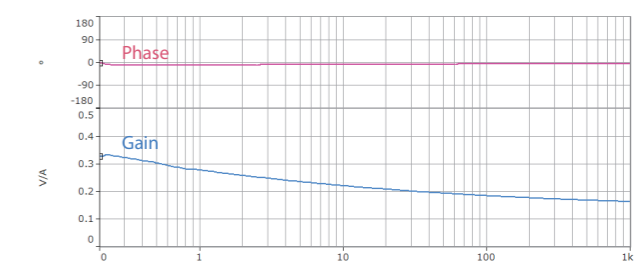

Image of measurement results

Cole-Cole plot



A Cole-Cole plot is a graph that shows the real part of the frequency response function on the horizontal axis and the imaginary part on the vertical axis. It is useful to examine an equivalent circuit.



High speed, low voltage, electronic load device ELL-355 (Keisoku Giken Co., Ltd.)

Power	350 W
Voltage	30 V
Current	135 A
Internal impedance	3 mΩ/80 nH

Basic system



List of DS-5000 unit

Model	Product
DS-5100	Main unit
DS-0501	Battery unit
DS-0502	Power Supply Interlocking function
DS-0523	3ch 40 kHz input unit
DS-0526	6ch 40 kHz input unit
DS-0532	2ch 100 kHz input unit
DS-0534	4ch 100 kHz input unit
DS-0542	2ch external unit
DS-0543	2ch external unit & 1ch signal output unit
DS-0544	4ch external unit
DS-0545	2ch signal output unit

The DS-5000 series Data Station is a unit expandable type measurement system. You can design according to your application and purpose by adding various units. Input, signal output, and battery etc. required units can be added to the DS-5100 main unit.



Outer dimensions

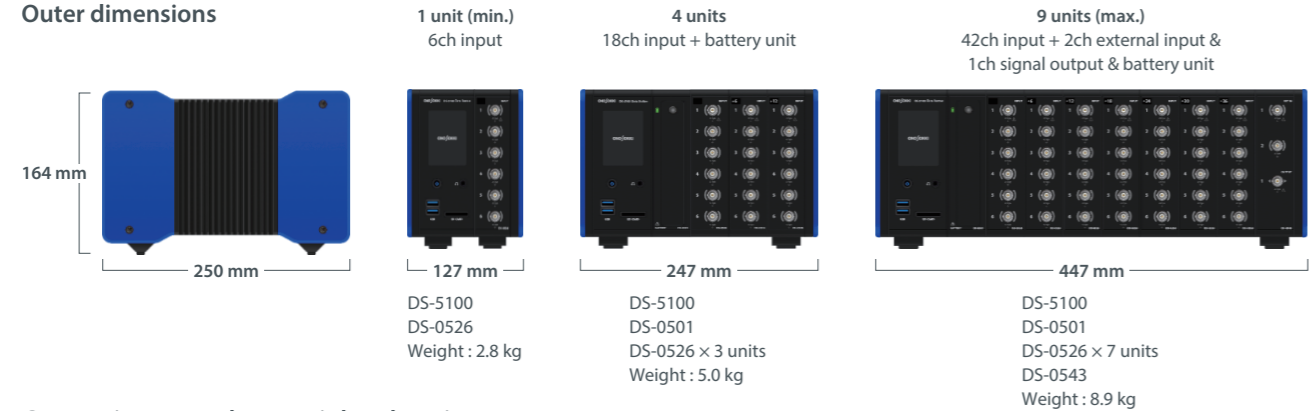

Connection example to peripheral equipment

DS-5000 series Data Station

DS-5100	Main unit	Left
DS-0501	Battery unit	Middle
DS-0526	6ch 40 kHz Input unit	Right

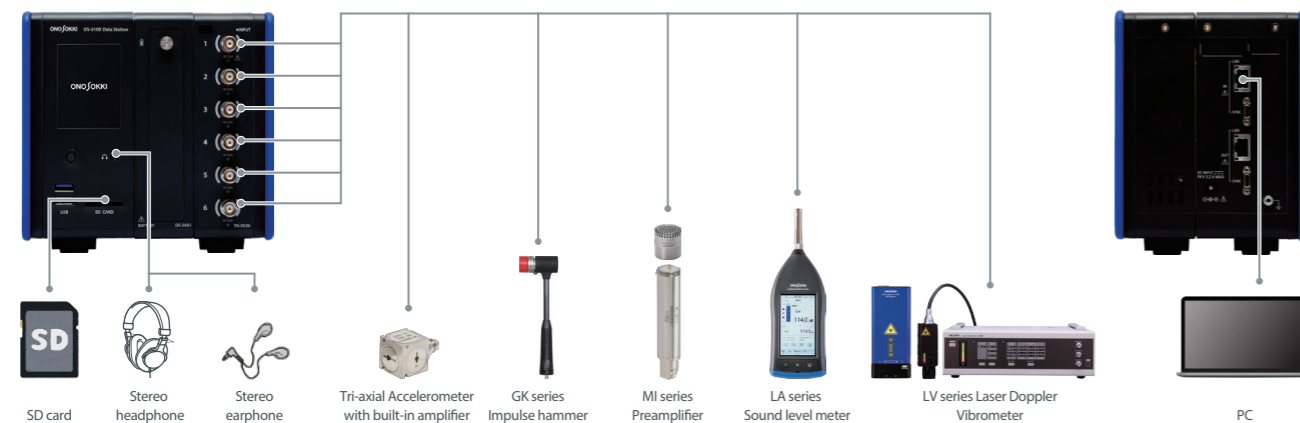

Features

Easy cable connection

The pitch is designed for easy cable connection. Downsizing and easy operation are both achieved.



Easy to carry

The design of U-shaped bottom makes it easy to carry anywhere; carried on a cart, placed on a table, set in a narrow space.



Extendable & expandable measurement system

The stack structure enables to build the system according to your application. Multi-channel measurement up to 240 channels* is available.

* when 5 units connected

* Max. channels in one hardware: 48 channels



Easy to notice the level range over

Arc-shaped LEDs on both sides of the connectors let you know the over-range channels on both hardware and software.



Battery-powered to use anywhere

Readily to use outdoors, in factories and other places even where a power sources not easy to secure. (approx. 4 h meas. for a unit with 6-ch input)

By installing the Power Supply Interlocking function (DS-0502), you can turn on/off the DS-5000 main unit by operating the power switch of control panel.

*The Battery Unit (DS-0501) is required.



Less affected by external noise

Each channel is isolated. You can measure safely even in the field or the object where is likely to have ground loop, electrical noise and potential differences.

Providing audio checking for reliable measurement

Main unit has an output connector for headphone monitor. The measured input signal can be checked with sound.



Individual recording function

Highly accurate recording without a PC

Recording can be performed using only the DS-5000 at the measurement site. It is convenient for on-board measurement, data recording at sites where a PC cannot be brought in, or where measurement time is limited.



Marker function allows further analysis on specified area

You can add markers to the specified areas in the long recorded data. Also set the analysis range based on the marker.



Condition can be set in advance with the O-Solution

By importing the condition file (calibration value, voltage range, etc.) prepared on the O-Solution in advance, you can use the DS-5000 as high-precision data logger.

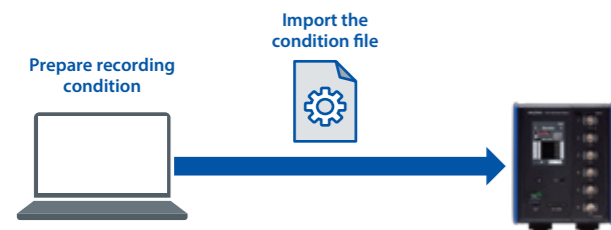

Simple operation with touch panel

You can easily start and stop recording using the touch panel.



Operate from a smartphone/tablet

A remote control app for smartphones and tablets is available so that you can easily start/stop recording and check or change settings without a PC. The app does not need to be installed and can be used with a web browser. You can also monitor the voltage range and give instructions to start and stop measurements using your smartphone.

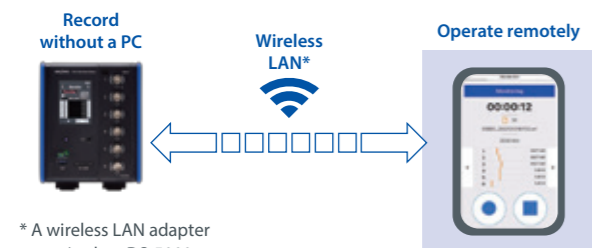

* A wireless LAN adapter required on DS-5000

Further analyzing the recorded data with the O-Solution

Recorded data can be saved in a memory such as an SD card, and detailed analysis can be performed by importing the recorded data to O-Solution.



Measurement of outdoors, factories

Using the battery unit and individual recording function enables vibration and acoustic measurement even outdoors, factories or in places where power is not available.

System configurations

Model	Product name
DS-5100	Main unit
DS-0526	6ch 40 kHz Input unit
DS-0501	Battery unit



Battery unit



Sound and vibration measurement while driving a car

Recording can be easily performed without a PC by using the individual recording function even when driving a car. By recording not only sound and vibration but also rotation speed and vehicle speed at the same time and importing the data into the O-Solution, it is possible to investigate the cause of sound and vibration.



Ex) Sound and vibration measurement during EV acceleration

Simultaneously measure sound vibration, rotation speed, and vehicle speed at the driver's ear position and near the power unit in order to investigate the cause of the sound heard at the driver's ear position during acceleration of the EV.

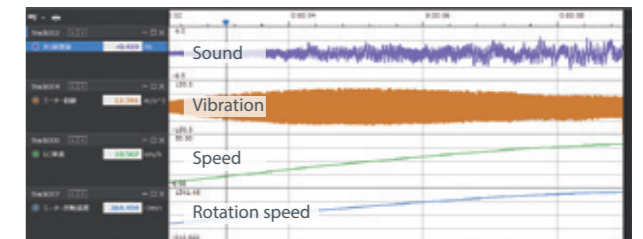

FFT Tracking Analysis

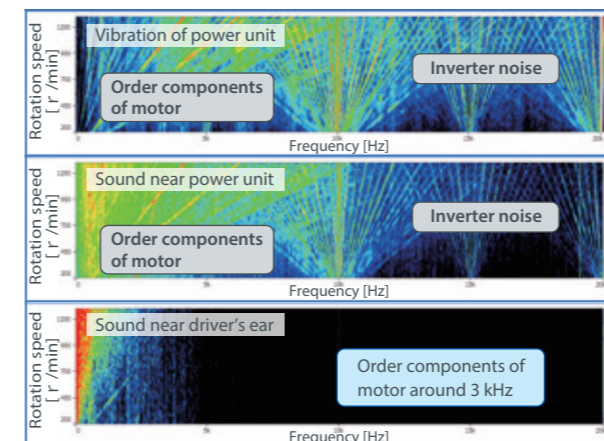

Sound quality evaluation

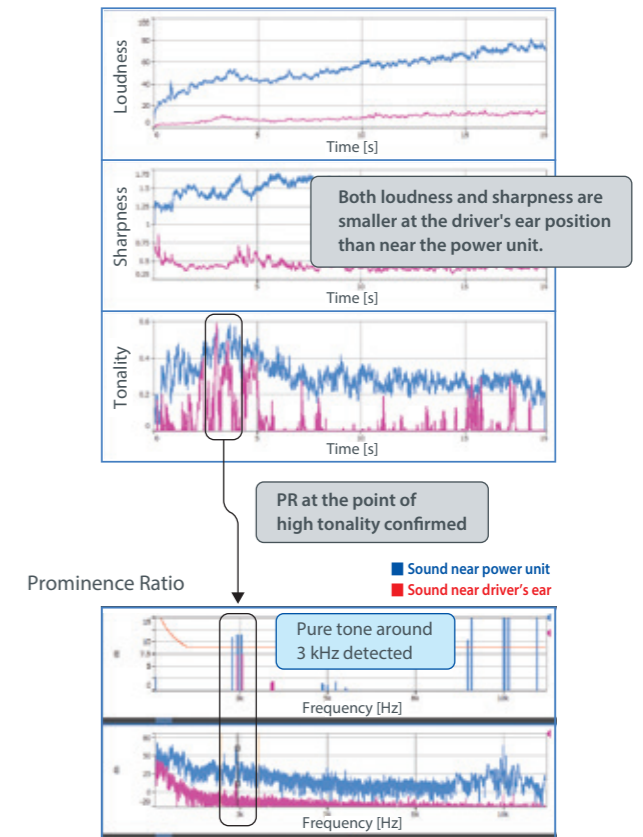

System configurations

Model	Product name
DS-5100	Main unit
DS-0526	6ch 40 kHz Input unit
DS-0542	2ch External input unit
DS-0501	Battery unit
OS-5100	Platform
OS-0522	FFT Analysis Function
OS-0523	Tracking Analysis Function
OS-0525	Sound Quality Evaluation Function
OS-0512	Hardware Connection Function

Ultra-compact Tri-axial Accelerometers NP-3550

The NP-3550 ultra-compact tri-axial accelerometer is the smallest & lightest in the industry.



Sensitivity	1.02 mV/(m/s ²) ±20 %
Frequency range	2 Hz to 5 kHz (X) ±5 % 2 Hz to 8 kHz (Y) ±5 % 2 Hz to 8 kHz (Z) ±5 %
Weight	1.0 g
Outer dimensions	6.35 (W) × 6.35 (D) × 6.35 (H) mm

Ultra-miniature Microphone MB-2200M10

The MB-2200M10 is an ultra compact and lightweight microphone that enables measurement in narrow spaces, where have been difficult to install, without giving influence to the sound field.



Sensitivity(1 kHz)	-37.0 ±3 dB re.1 V/Pa (14 mV/Pa)
Frequency range (1 kHz reference)	200 Hz to 16 kHz (± 2.5 dB)
Self-noise level	36 dB or less (A-weighting)
Outer dimensions	Sensor part : 4.7 (W) × 7.1 (D) × 3.3 (H) mm
Weight	Approx. 0.3 g (sensor part only)

Application examples

Measuring natural vibration frequency and damping ratio

For countermeasure of vibration or noise, it is important to understand the unique vibration characteristics of the target (structure such as machinery and automobile parts). The O-Solution can measure frequency response function in excitation experiments using impulse hammers or exciters. The damping ratio and logarithmic decrement can be calculated with half width method and Hilbert transform.

Measurement system

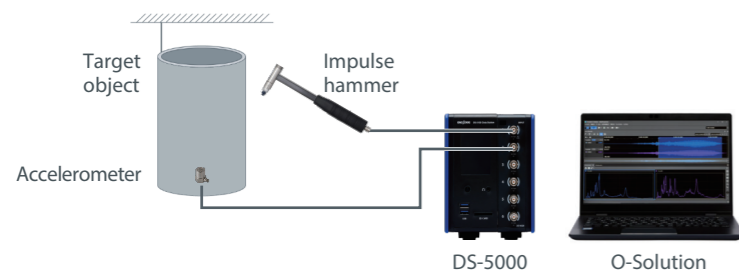

System configurations

Model	Product name
DS-5100	Main unit
DS-0526	6ch 40 kHz Input unit
OS-5100	Platform
OS-0522	FFT Analysis Function
OS-0512	Hardware Connection Function

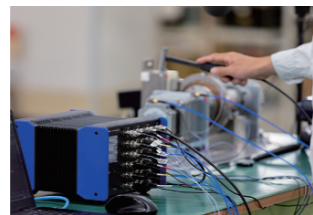

Analysis results

Hammering test

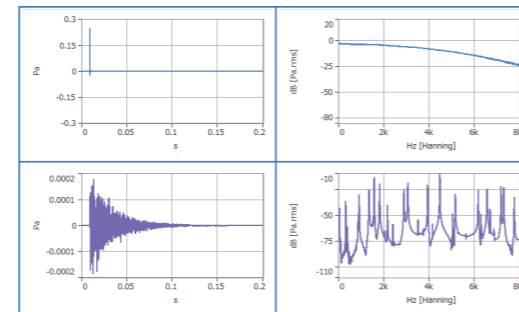

Frequency response function/coherence

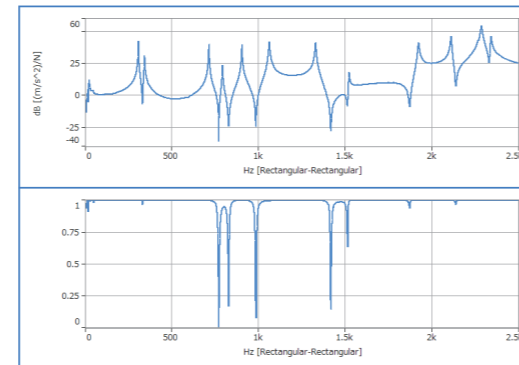

Sound analysis of small motor

Record the sound generated by the motor with the high-performance Sound Level Meter LA-7000 series and analyze in detail with the O-Solution. By importing recorded data (wav format) into O-Solution, you can perform sound playback, frequency analysis, octave analysis, and sound quality evaluation that takes into account human hearing on a PC.

Measurement system

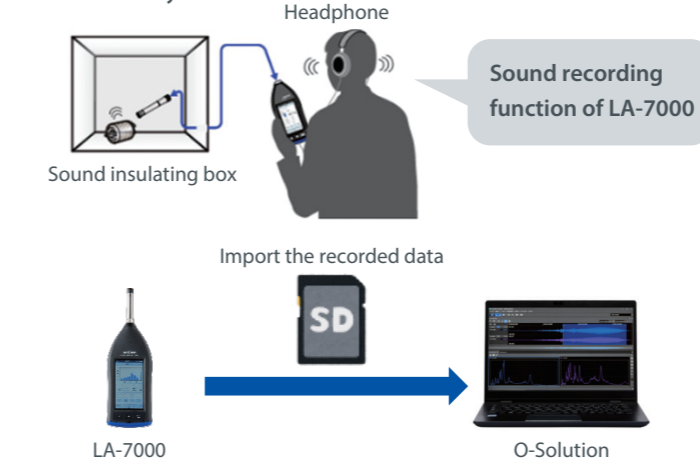

System configurations

Model	Product name
OS-5100	Platform
OS-0522	FFT Analysis Function
OS-0524	Octave Analysis Function
OS-0525	Sound Quality Evaluation Function

Analysis results

1/3 Octave analysis A-weighting sound pressure level

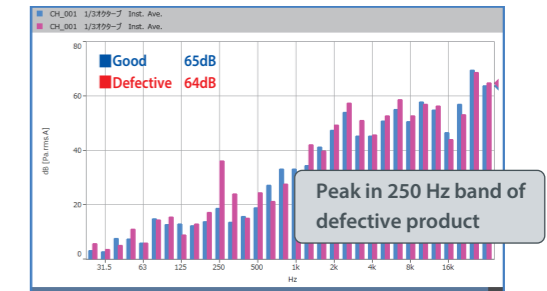

Prominence Ratio Power spectrum

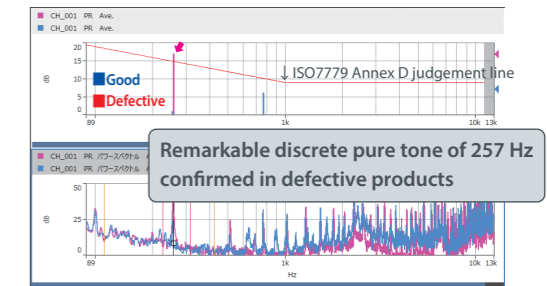

Development of silent technology for air conditioning equipment

By performing FFT and octave analysis simultaneously, it is not only to detect the target frequency, but also to measure simultaneously sounds and vibrations.

Measurement system

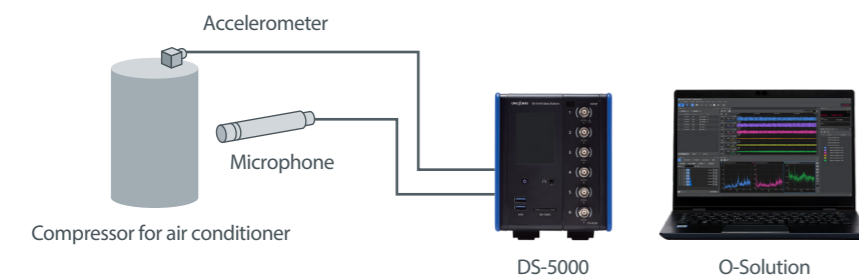

System configurations

Model	Product name
DS-5100	Main unit
DS-0526	6ch 40 kHz Input unit
OS-5100	Platform
OS-0522	FFT Analysis Function
OS-0524	Octave Analysis Function
OS-0512	Hardware Connection Function

Analysis results

FFT and octave analysis in real time

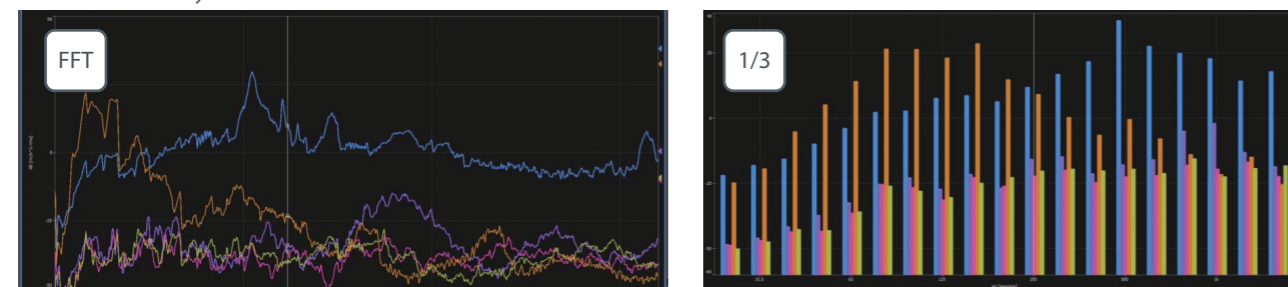

Identifying the cause of abnormal vibration with the Portable Vibration Meter

The Portable Vibration Meter VW 3100 enables to record while measuring and inspecting on site. By returning to the office and importing the recorded data into the O-Solution, you can listen to the sound while filtering it, and you can use FFT analysis to identify the cause of the abnormality.

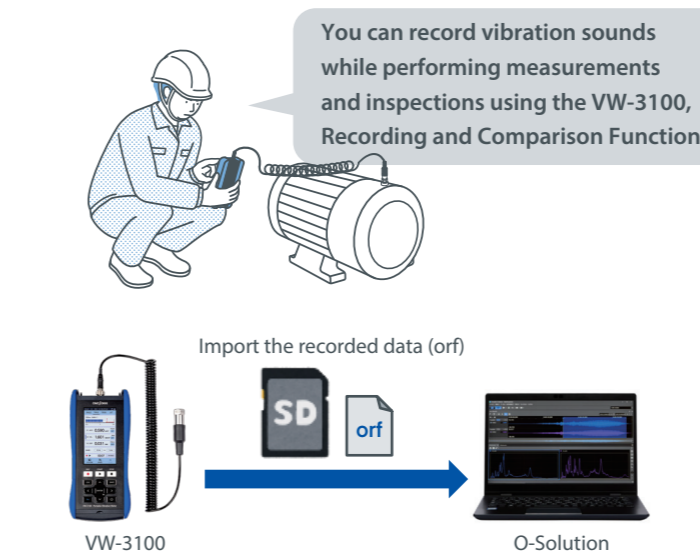

System configurations

Model	Product name
OS-5100	Platform
OS-0521	Digital Filter Function
OS-0522	FFT Analysis Function

Analysis results

IIR filter (Parametric Equalizer)

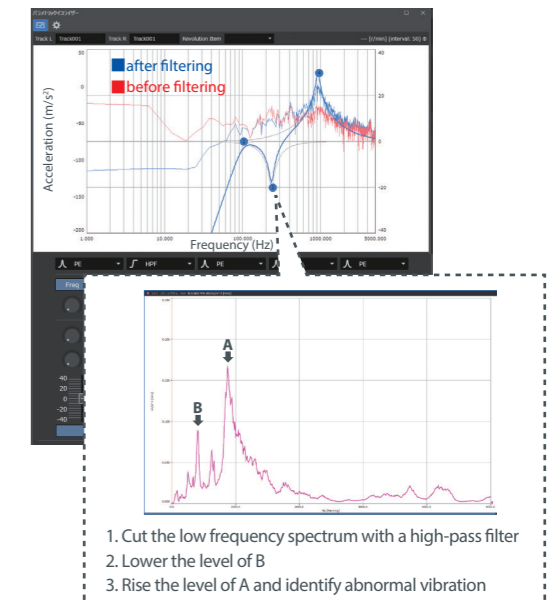

Application examples

Tracking analysis of rotating equipment

In the sound and vibration generated from rotating objects such as motors, generators, and transmission, it enables to measure at which rotation speed each order component increases. Tracking analysis of carrier noise (offset tracking) generated from the switching signals of an inverter can be performed.

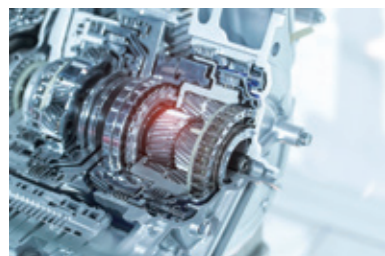

Analysis results

Tracking diagram

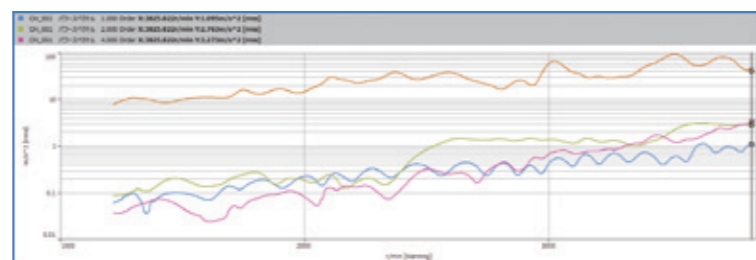

Color map

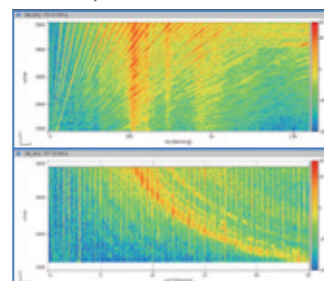

3D graph

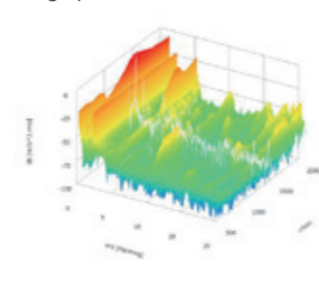

System configurations

Model	Product name
DS-5100	Main unit
DS-0526	6ch 40kHz Input unit
DS-0542	2ch External input unit
OS-5100	Platform
OS-0522	FFT Analysis Function
OS-0523	Tracking Analysis Function
OS-0512	Hardware Connection Function

Torsional vibration measurement of motors, engines, etc.

Torsional vibrations in engine crankshafts and propeller shafts may cause shaft damage and noise and vibration problems. Therefore, it is important to measure torsional vibration and understand the phenomenon of torsional resonance.

The Laser Doppler Surface Velocity Meter LV-7000 series can detect speed, uneven speed, length without contact. By using 2 sensors, it enables to calculate difference in velocity/length.

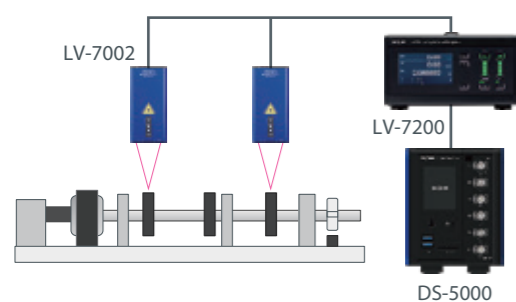

Analysis results

Time waveform

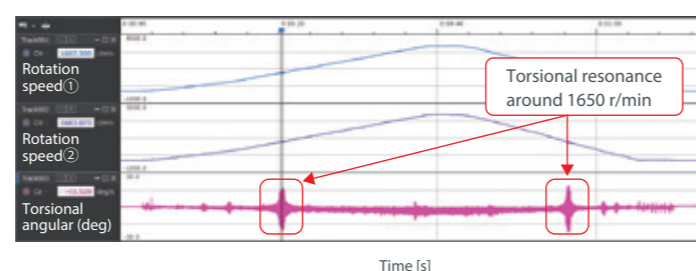

Tracking analysis (changing order according to rotation speed)

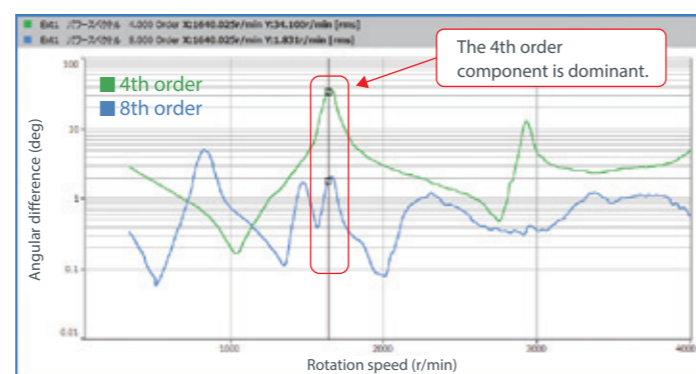

System configurations

Model	Product name
DS-5100	Main unit
DS-0526	6ch 40 kHz Input unit
OS-5100	Platform
OS-0522	FFT Analysis Function
OS-0523	Tracking Analysis Function
OS-0512	Hardware Connection Function

Data analysis acquired on test bench

The O-Solution can analyze a large amount of data acquired by test system (engine bench, motor bench, etc.). Equipped with various functions such as enlarged waveform, data search, moving average, and RMS calculation. Using the OS-0531 statistical analysis function enables to calculate correlation functions.



System configurations

Model	Product name
OS-5100	Platform
OS-0531	Statistical Analysis Function

Analysis results

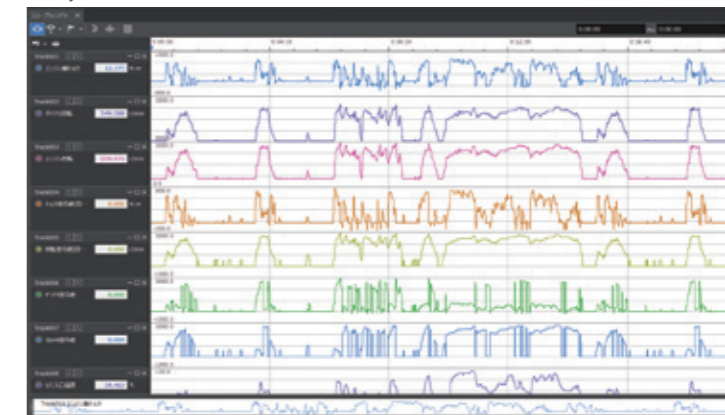

Statistical analysis function



Revolution of dynamo correlation function 0.99

Shaft torque correlation functions 0.98

Actual vehicle NV test

Actual vehicle NV test is performed using a combination of FFT analyzer and GPS speedometer. Input the digital signals output from the LC-8300A to the DS-5000, apply trigger, and execute synchronized recording. With the various functions of LC-8300A, you can perform tests with good reproducibility.

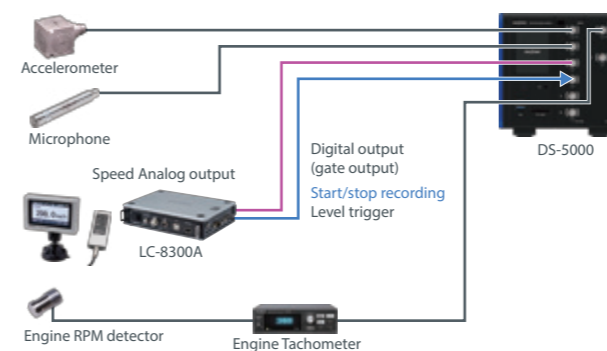

System configurations

Model	Product name
DS-5100	Main unit
DS-0526	6ch 40 kHz Input unit
DS-0542	2ch External input Unit
DS-0501	Battery Unit
OS-5100	Platform
OS-0522	FFT Analysis Function
OS-0523	Tracking Analysis Function
OS-0512	Hardware Connection Function

Measurement results

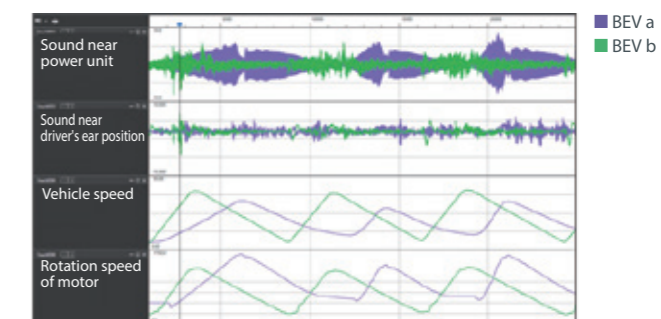

Analysis results

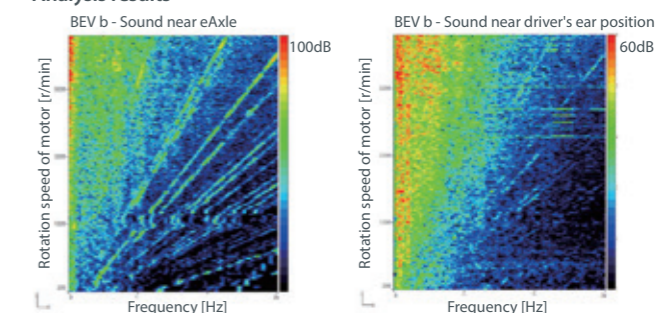

Application examples

Offset tracking analysis

Automotive parts manufacturers intentionally change the carrier frequency of the inverter to avoid increasing the natural frequency and order components of the parts itself, and take measures to prevent unpleasant sounds from occurring. The offset tracking analysis enables to perform order ratio analysis by following changes in carrier frequency according to rotation.

System configurations

Model	Product name
DS-5100	Main unit
DS-0526	6ch 40 kHz Input unit
DS-0542	2ch External input unit
DS-0501	Battery unit
DS-0502	Power Supply Interlocking Function
OS-5100	Platform
OS-0522	FFT Analysis Function
OS-0523	Tracking Analysis Function
OS-0512	Hardware Connecting Function

Analysis results (Constant width tracking analysis)

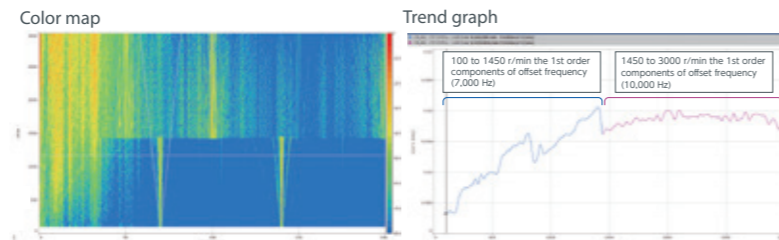

By specifying the offset frequency and the lower and upper limits of rotational speed, it is possible to analyze a specific order even if the carrier frequency changes accordingly at a certain rotational speed.

In combination with Noise testing software

It is effective for multi-channel measurement to use the DS-5000 in combination with the Noise testing software which has a comparator function for abnormality diagnosis. You can perform simultaneously the tracking analysis and pass/fail judgment for 2 rotation input channels.

It is ideal for vibration analysis of CVT and in-line 100% inspection such as carrier noise analysis of motors.

Measurement system

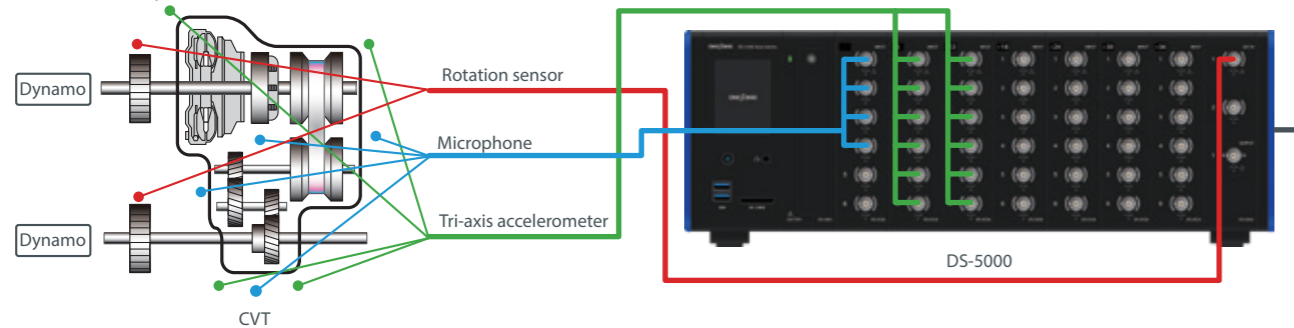

System configurations

Model	Product name
DS-5100	Main unit
DS-0526	6ch 40 kHz Input unit
DS-0542	2ch External input unit
DS-0501	Battery unit
DS-0502	Power Supply Interlocking Function
GN-1200	Noise Testing Software

OK

NG

External control
RS-232C / LAN / DIO

Noise Testing Software GN-1200 series

GN-1200 Noise Testing Software

Number of maximum channels	32ch
Frequency analysis range	40 kHz (2 to 8ch), 20 kHz (10 to 16ch), 10 kHz (18 to 32ch)
Frequency analysis	FFT 6400 lines / bundled of octave
Maximum analysis order	1600th order
Rotation reference	Rotation 1 / Rotation 2 / Calculation rotation

- Pass/fail judgment of data analyzed by setting threshold value
- Simultaneous analysis for measured signals to reduce cycle time
- Automatic measurement using communication

Visualization of vibration behavior of structures

By combining the DS-5000 with the experimental modal analysis software, it enables to visualize the natural vibration frequency and vibration behavior of structures such as motors and automobile bodies. By configuring multiple channels, multiple points can be measured simultaneously. Thus, the measurement time can be significantly reduced.



System configurations

Model	Product name
DS-5100	Main unit
DS-0526	6ch 40 kHz Input unit
OS-5100	Platform
OS-0522	FFT Analysis Function
OS-0512	Hardware Connection Function
AX-9055	Hardware connection cable (3 m)
-	LAN cable for hardware connection
-	Experimental modal analysis software

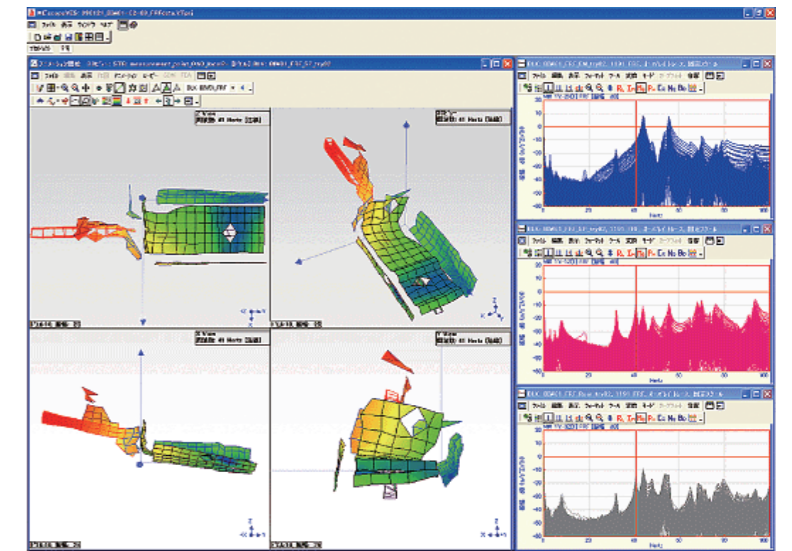

The modal parameters obtained with MIMO (Multiple Input/Multiple Output) can be used to update the CAE model.

Experimental modal analysis

- Definition of the measured shape.
- Degree of freedom setting for measurement data
- ⇒ Animation based on measurement data

Extracting modal parameters
(Creating shape data by curve fitting)

Natural vibration measurement of fixed floors or plates for installing precision equipment (Experimental modal analysis)

Vibrations are often related to the underlying causes of machinery breakdowns and quality issues in manufacturing, and understanding the vibration conditions during operation as well as the natural frequencies is essential. By understanding the vibration shape using the O-solution + the experimental mode analysis software, you can check whether resonance phenomena are occurring.

Measurement system

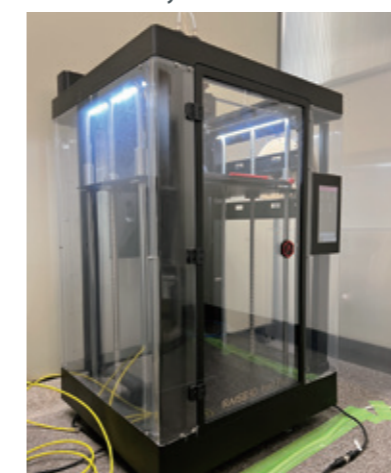

Measurement target: 3D printer

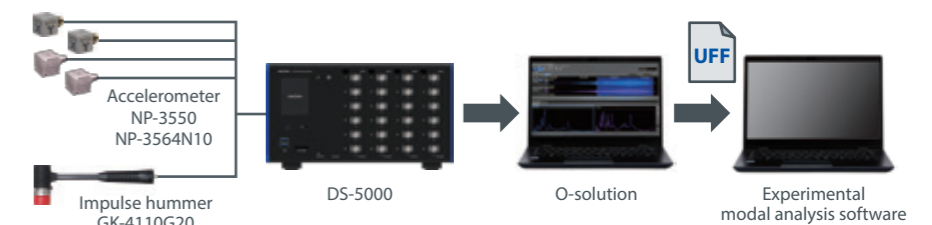

System configurations

Model	Product name
DS-5100	Main unit
DS-0501	Battery Unit
DS-0526	6ch 40 kHz Input unit
OS-5100	Platform
OS-0522	FFT Analysis Function
OS-0512	Hardware Connection Function

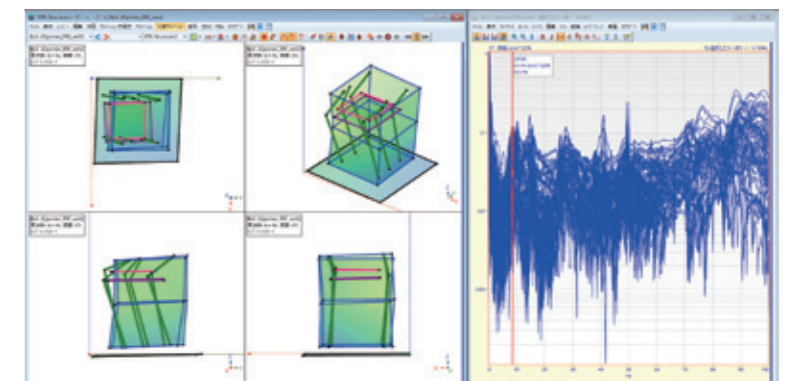

- Understand vibration phenomena
- Identify the location of occurrence
- Investigate cause of occurrence
- Devise a reduction method
- Confirm the effect after taking measures

Experimental modal analysis is efficient for analyzing the natural frequency and natural mode shape which always change depending on the position of the machine tool robot arm, stage, etc.

Specifications DS-5000

Main unit (DS-5100)	
System configuration	
Maximum number of input channels	40 kHz system 48ch ^{(*)1} 100 kHz system 4ch
Max. number of external input channels (revolution/trigger)	40 kHz system 4ch ^{(*)2} 100 kHz system 4ch
Maximum number of output channels ^{(*)3}	40 kHz system 6ch 100 kHz system 2ch
Maximum number of input/output units ^{(*)4}	40 kHz system 8 units 100 kHz system 3 units
Hardware to hardware connection	40 kHz system : Max. 5 units 100 kHz system : Nil
Interface	
LCD with touch panel	<ul style="list-style-type: none"> Status display Battery status, etc.
LAN RJ45 connector	Connection terminal : 2 points <ul style="list-style-type: none"> between PCs between main units
Hardware connector	Used to connect 2 or more main units IN × 1 / OUT × 1
Output connector for headphone monitor	Stereo φ 3.5 connector

*1: All installed units are input units.

*2: When Hardware-to-Hardware connection used, input is available from the first channel of the hardware connected to a PC to the 10th one.

*3: Output is available only for hardware connected to a PC.

*4: Main unit and battery unit are excluded.

*5: For DS-0523, DS-0532, 2 units or more cannot be installed.

*6: 2ch External Input
Specification is equivalent to DS-0542, DS-0544.

*7: 1ch Signal Output
Specification is equivalent to DS-0545.

40 kHz Input Unit (DS-0523/0526) 100 kHz Input Unit (DS-0532/0534)	
Number of input channels	[40 kHz] DS-0523 : 3ch ^{(*)5} DS-0526 : 6ch [100 kHz] DS-0532 : 2ch ^{(*)5} DS-0534 : 4ch
Input terminal	BNC
Input impedance	1 MΩ ±0.5 % 100 pF or less
Input format	DC or AC • -3 dB at 0.5 Hz ±10 % • AC set automatically when using CCLD
Isolation	42.4 Vpk • Between BNC ground and hardware, and between each BNC ground
Sensor power supply (CCLD)	+23 V to 26 V / 4 mA±25 % (25 °C)
TEDS function	<ul style="list-style-type: none"> IEEE 1451.4 Ver. 0.9/1.0 Acceleration sensors and microphones supported IEEE 1451.4 Ver. 1.0 Power sensors supported
Input voltage range	-30 / 0 / +30 dBVrms
Absolute maximum input voltage	50 Vpk (DC to 100 kHz)
Input level monitor	Red LED turned on by excessive input (turned on at range FS)
Frequency range	[40 kHz] DC to 40 kHz [100 kHz] DC to 100 kHz
Sampling frequency	2.56 times of the frequency range
A/D converter	24 BitΔΣ type
Dynamic range	[40 kHz] 130 dB 40 kHz range, 0 dBVr range, analysis for 4096 points, 1 kHz or more [100 kHz] 120 dB 100 kHz range, 0 dBVr range, analysis for 4096 points, 1 kHz or more
Channel-to-channel phase accuracy	Channels in the hardware • Less than 20 kHz: ±0.1 ° • 20 kHz or more: ±0.7 ° When hardware to hardware connection (40 kHz system only) • Less than 20 kHz ±0.6 ° • 20 kHz or more ±1.2 °

External input & Signal output unit (DS-0543)	
Number of input channels	2ch ^{(*)6}
Maximum number of output channels	1ch ^{(*)7}

Battery Unit (DS-0501)	
External DC power input voltage	DC10 V to 28 V
Battery pack (option)	Lithium-ion battery pack • manufactured by RRC, RRC2020 99.6 Wh
Drive time	Approx. 4 hours • at outside temperature of 25 °C • when using DS-5100 + DS-0526
Charging time	Approx. 4 hours • main unit power off • at remaining amount of battery pack 0 %
Dedicated charger (sold separately)	Dedicated charger manufactured by RRC
External DC power cable (sold separately)	5 m (alligator cable with fuse)

External Input Unit (DS-0542/0544)	
Number of input channels	DS-0542 : 2ch DS-0544 : 4ch
Max. number of external input channels (revolution/trigger) ^{(*)2}	40, 100 kHz: up to 4ch • DS-0542×2 unaccepted • Coexistence with DS-0543
Maximum input voltage	30 Vrms (42.4 Vpk)
Absolute maximum input voltage	50 Vpk
Hysteresis level	Set desired level (default 0.5 V, range 0.02 to 80 V)
Number of input pulses/revolution	0.5 to 3600 P/R
Input pulse division function	1 to 3600 divisions (in increments of 1) • Input frequency 4 kHz or more required
Input coupling	AC or DC
Input impedance	100 kΩ ±0.5 %
Isolation	42.4 Vpk • Between BNC ground and hardware, and between each BNC ground
Input frequency	Max. 300 kHz (with out-of band filter)

Recommended product for Individual recording function	
Wireless LAN Module	TL-WN725N

* Please refer to our website for the latest information on recommended SD cards/ external SSDs.

Signal Output Unit (DS-0545)	
Number of output channels	2ch
Maximum number of output channels	40 kHz: up to 6ch • 3 units • Coexistence with DS-0543 • Output is available only for hardware connected to a PC. 100 kHz : up to 2ch • 1 unit • Coexistence with DS-0543
Signal type	Since wave, swept sine, random (no inter-channel correlation), pseudo random, impulse, octave band noise, pink noise, record data
Applicable FFT analysis length	64 to 16384 (power of 2)
Burst function	Available (continuous/single)
Taper function	Available
Output terminal	BNC
Output impedance	0 Ω or 50 Ω ±10 %
D/A converter	24 bit ΔΣ type
Isolation	42.4 Vpk • Between BNC ground and hardware, and between each BNC ground
Output voltage amplitude	±1 mV to ±10 V
Offset voltage	±10 V
Max. output current	10 mA
Frequency range	40 kHz : 0 to 40 kHz 100 kHz : 0 to 100 kHz

Accessories	
AC adapter	: 1
Power cable for AC adapter	: 1
LAN cable (3 m)	: 1 Connects the DS-5000 series Data Station with a PC
Instruction manual	: 1

AC adapter	
Input voltage / current	AC100 to 240 V 50 to 60 Hz / 1.2 A MAX.
Output voltage / current	DC19 V / 4.74 A

DS-5000

General specifications	
Outer dimensions	130 to 450 mm (W) × 160 mm (H) × 220 mm (D)
Power consumption	67 W or less
Operating temperature range	-10 °C to 50 °C (humidity 20 to 80 %RH, no dew condensation)
Storage temperature range	-20 °C to 60 °C (humidity 20 to 80 %RH, no dew condensation)
Weight	Min. 2,800 g (DS-5100 & DS-0526) Max. 8,900 g (DS-5100, DS-0501 & DS-0526 × 8)
Cooling fan	Available (Silent fan) Sound power level (Lw A-weighted) : 38 dB or less when using DS-5000 48ch It operates when internal temperature rises.
Applicable standards (CE marking)	Low Voltage Directive 2014/35/EU standard EN61010-1
	EMC Directive 2014/30/EU standard EN61326-1
	RoHS Directive 2011/65/EU standard EN IEC 63000

O-Solution

OS-4100 (Hardware)		
Number of measurement channels	40 kHz unit	3 to 42 ch
	100 kHz unit	2 to 4 ch
Dynamic range	40 kHz unit	FRA mode : 160 dB FFT mode : 130 dB
	100 kHz unit	FRA mode : 160 dB FFT mode : 120 dB
Output voltage	Max. ±10 V (Peak) including offset voltage and amplitude	
Type of output signal	Sine/ Sine sweep (log/ Linear)/ Swept sine/ Random/ Pseudo-random/ Impulse	
Addition function	Installed in DS-0545 2ch Signal output unit (MIX IN)	
Coupling	AC/DC automatic switching function	

OS-4100 (Software)	
Measurement frequency range	40 kHz unit : 10 mHz to 40 kHz 100 kHz unit : 10 mHz to 100 kHz
Calculation method	FRA mode : Sine sweep (Log/Lin) FFT mode : Random, swept, pseudo-random, impulse
Frequency resolution	FRA mode : Log 2 to 2000 (Line/Decade) Lin 200 to 25000 (Line/Total) FFT mode : Max. Sampling points 65536
Measurement functions	FRA mode : Output amplitude control, Frequency range division setting (up to 30), Auto resolution control FFT mode : Pair range
Calculation functions	Gain margin/ phase margin, damping ratio, loss factor, cutoff search, step response (delay time, overshoot)
Graph display	Bode, time waveform, power spectrum, Nyquist, co-quad, Nicols, cole-cole plot

Specifications O-Solution

Viewer (O-Solution Lite)

The O-Solution Lite can be used without a license. With the DS-5000, recording of time waveforms is available. The OS-5100 (O-Solution platform) has basic arithmetic processing functions for time-series data. Add each option according to your application. The OS-0512 is required to use the option in measurement mode.

Time series data recording (measurement mode only)

Recording function (external and input channels are included.) ^{*1, *2}	1 to 20ch : 40 kHz
	21 to 40ch : 25 kHz
	41 to 120ch : 20 kHz
	121 to 240ch : 10 kHz
	1 to 4 ch (when using 100 kHz input unit) : 100 kHz

*1: For the individual recording, only for a single hardware unit. (up to 48 ch)
*2: For the individual recording, the maximum number of channels for 40 kHz is 18 channels. Other than 40 kHz are as shown in the table above.

Platform (OS-5100)

Supported data

Sampling frequency	Measurement mode	The time series data which can be acquired by the DS5000 series Data Station. • 40 kHz Input Unit (DS-0523 / DS-0526) : 2.56 Hz to 102.4 kHz (frequency range: 1 Hz to 40 kHz) • 100 kHz Input Unit (DS-0532 / DS-0534) : 2.56 Hz to 256 kHz (frequency range : 1 Hz to 100 kHz)	
	Analysis mode	10 μHz to 100 GHz (frequency range : 3. 9 μHz to 39 GHz)	
Time series data import	Number of files	Maximum 1000 files	
	Number of channels	Maximum 65536 channels	
	Number of data points	Maximum 1 TB	
File import format (Time series data)	• ORFX, ASCII, WAVE, MDF, ORF, FAMS, UFF • Graphtec GBD file • TEAC TAFM file • HIOKI MEMORY HiCORDER file • Yokogawa WDF/WVF file		
File import format (Analysis data)	• DATX, DAT, TEXT, TRC		
File export format (Time series data)	• ORFX, CSV, WAVE, UFF, PNG (image)		
File export format (Analysis data)	• TEXT • UFF • PNG (image)	• DATX • CSV	

Time axis preprocessing

Overview	Calculation processing is performed on a time waveform acquired before executing FFT analysis.
Digital filter	LPF, HPF, BPF, A-weighting, C-weighting LPF, HPF, and BPF are all 6th-order Butterworth filters. BPF is also the 6th-order filter coefficient, thus the slope is -18 dB/oct instead of -36 dB/oct.
Absolute value	Supported
Time axis calculus	1st derivative, 2nd derivative, single integral, double integral
DC removal before integration	Supported

Trigger

Source	Measurement mode	Internal, external, level
	Analysis mode	Item
Mode	Repeat, OneShot	
Operation	Start, stop, start and stop	
Others	Double-hammer cancel provided.	
	Undo averaging provided.	
	Prerecording function provided. • Recording can be started a few seconds before trigger detection.	
	Data can be acquired using the trigger function during recording.	
	Display function (time monitor and time waveform)	

Recording (measurement mode only)

Analysis during recording	• Analysis is performed during recording. (Optional function required to execute analysis.)
Prerecording function	• Recording can be started a few seconds before the trigger is fired.
Trigger stop function	• Recording is stopped using the trigger function.

Data settings (analysis mode only)

Signal correction	Calibration for the reference signal is available.
Level adjustment	Level is adjusted to a desired level for imported data. Scale: Decibel, linear
	Level adjustment method: Target value, rate of change (when selecting two or more) Spectrum display format: rms, 0-Peak, Peak-Peak
	Time series data positions can be aligned. • When performing recording using two or more measuring instruments, the position of each piece of data needs to be aligned for the data having different recording timings. • The position of each piece of data can be aligned by setting a trigger for the reference signal.
Time series position alignment	Reference interval: All intervals or predetermined interval This can be executed for all the items of the same file as the target item. A marker is placed at the time of position alignment.
Edit File	The time series data recorded in a different file can be edited.

Time series calculation (analysis mode only)

Re-sampling	Acquired time series data can be changed to a desired sampling frequency. Algorithm: Cyclic convolution interpolation and linear interpolation
Pulse converter	Revolution pulse signal can be converted to revolution speed. The number of pulses per revolution can be set. Unit: r/min, km/h, m/min, m/s
Event counter	Search conditions can be output to count data.
Moving average	Moving average processing can be performed for the desired averaging count.
Time axis calculus	1st derivative, 2nd derivative, single integral, double integral, function for removing DC component before integration provided, unit conversion function provided.
Effective value calculation	Frequency weighting, time constant, and output time interval can be set.
Hilbert transformation	Conversion to amplitude, phase, or instantaneous frequency can be performed.
Remove abnormal rotation speed	Abnormal revolution speed data can be removed by setting a threshold.
Frequency weighting	A, C, G, Vv, Vh
Statistical trend calculation	Calculation between item data can be performed.
Statistical trend calculation	Calculation between item data can be performed.
Statistics window	
Static	Difference / Sum / Average / Median / Max - Min / Max / Min / Standard deviation / Effective value / Peak to peak/Local max / Local min / Skewness / Kurtosis / Form factor / Crest factor / Abs. average / Area / Area + / Area - / Left value / Right value
File export format	CSV
Others	Linked with the selected range in [Scope Window].

Analysis result averaging

Item link	• On: The same items in checked files are averaged. • Off: All the checked items are averaged.
Others	Summation averaging can be performed for the frame graph data of the items after FFT or octave analysis.

Calculation within analysis result file

Supported analysis data	FFT analysis, FFT tracking analysis, octave analysis, and octave tracking analysis
-------------------------	--

Replay analysis (measurement mode only)

Overview	The state of real-time measurement in the measurement mode can be reproduced using recorded time series data.
Others	Interval setting of the target time series data for replay analysis can be performed.
	The playback speed of replay analysis can be set (0.25 to 2.0 times). You can make the cursor in [Scope Window] follow the playback position of replay analysis.

Digital Filter Function (OS-0521)

FIR filter (analysis mode only)

Processing interval	All intervals or predetermined interval	
Preview settings	Analysis mode	128 / 256 / 512 / 1024 / 2048 / 4096 / 8192 / 16384 / 32768 / 65536
	Averaging	Summation averaging (count)
	Smoothing function	Type1/ Type2
Frequency range	Lower and upper limit frequencies can be set to desired values.	
Level settings	Increase / decrease can be set at a desired level. • Settable range for increase/decrease is ±100 dB. The filter can have a slope by linear interpolation.	

IIR filter Parametric Equalizer (analysis mode only)

Filter	Application	Frequency and order
	Number of filters	Maximum 20 pieces
	Filter type	PE / HPF / BPF / BR / LPF
Filter shape adjustment	Level adjustment	Adjustment to a desired level can be set. • Adjustable range is ±40 dB.
	Q value	A desired value can be set. • Settable range is 0.01 to 100.
	Harmonic	Simultaneous processing can be performed for Nth order frequency (order).
Filter shape adjustment (BPF, BR)	Pole	1 to 10
	1/ N OCT	0.1 to 24
Filter shape adjustment (HPF, LPF)	Pole	1 to 10
Revolution speed range	Up to 38, 400 r/min	

IIR filter Graphic Equalizer (analysis mode only)

Filter	Application	1/3 octave frequency band: 20 Hz / 25 Hz / 31.5 Hz / 40 Hz / 50 Hz / 63 Hz / 80 Hz / 100 Hz / 125 Hz / 160 Hz / 200 Hz / 250 Hz / 315 Hz / 400 Hz / 500 Hz / 630 Hz / 800 Hz / 1 kHz / 1.25 kHz / 1.6 kHz / 2 kHz / 2.5 kHz / 3.15 kHz / 4 kHz / 5 kHz / 6.3 kHz / 8 kHz / 10 kHz / 12.5 kHz / 16 kHz / 20 kHz
	Number of filters	31
Filter shape adjustment	Level adjustment	A desired value can be set. • Adjustable range is ±40 dB • Set a value in increments of 0.1 dB.

FFT Analysis Function (OS-0522)	
Number of measurement channels	[Measurement mode] 3 to 240ch [Analysis mode] Imported time series data is targeted for execution.
Maximum analysis frequency range	1 to 20ch : 40 kHz 21 to 120ch : 20 kHz 121 to 240ch : 10 kHz 1 to 4ch (when using 100 kHz input unit) : 100 kHz
Number of FFT sampling points (spectrum lines)	[Measurement mode] 512 point (200 lines) to 32768 point (12800 lines) [Analysis mode] 512 point (200 lines) to 524288 point (204800 lines)
Analysis frequency range	[Measurement mode] 40 kHz unit : 1 Hz to 40 kHz 100 kHz unit : 1 Hz to 100 kHz [Analysis mode] • 3.9 μHz to 39 GHz (depending on the sampling frequency of import file) • At audio sampling 1.56 kHz to 37.5 kHz
Frequency zoom analysis	Limited to the analysis frequency range that can be set with the DS-5000.
Window function	Rectangular Blackman-Harris Hanning Exponential Hamming Force Flat-Top
Calculus function	1 st derivative, 2 nd derivative, single integral, double integral
Density calculation	PSD, ESD
Averaging function	Time axis summation averaging / exponential averaging Power spectrum summation averaging / exponential averaging Power spectrum peak hold Power spectrum sweep Power spectrum maximum O. A. Fourier spectrum summation averaging / exponential averaging Fourier spectrum maximum O. A.
Calculation function (time axis)	Time waveform (single frame) Autocorrelation function Cross-correlation function Impulse response Hilbert transformation
Calculation function (frequency axis)	Power spectrum Fourier spectrum Cross spectrum Frequency response function Coherence function Synthesized octave analysis (1 / 1, 1 / 3)
Frequency weighting	A-weighting, C-weighting, user-defined weighting
Overlap setting (in percentage)	90%, 75%, 66.7%, 50%, 25%, 0%
Overlap setting (number of samples)	Preference settings
Time interval specification (specifying overlap with time)	0.1 s / 0.2 s / 0.5 s / 1 s / 2 s / 5 s / 10 s / 20 s / 30 s / 1 min / 2 min / 5 min / 10 min
Special graph	Nyquist diagram, orbit diagram, mode circle, tripartite graph
Calculation function of frequency response function	Function type (H1/ H2) Loop function (close loop ↔ open loop) Inverse calculation
Others	Phase unwrapping Noise removal filter Delay between channels

Tracking Analysis Function (OS-0523)*1	
Common specifications	
Tracking method	Revolution, constant time
Revolution speed range	30 to 260,000 r/min The upper and lower limits change depending on the base sampling clock setting.
Revolution slope	UP, DOWN, Continuous UP/DOWN
Number of displayed tracking lines	24 lines • Up to 24 lines are registered in calculation.
3D tracking display	3D array display (monochrome/color) Color map display
Other functions	Preference unit setting (horizontal axis)
FFT Tracking (OS-0522 & OS-0523)	
Data type	Power spectrum, Fourier spectrum, cross spectrum
Number of sampling points (spectrum lines)	512 point (200 lines) to 32768 point (12800 line)
Analysis order	Order can be set arbitrarily from 6.25th to 3200th (6.25, 12.5, 25, 50, 100, 200, 400, 800, 1600, 3200)
Maximum number of blocks	5,000
Other functions	Multi-analysis supported Campbell diagram Offset tracking File averaging function Restart function Mode circle
Octave tracking (OS-0523 & OS-0524)	
Data type	1/1, 1/3, 1/6, 1/12, 1/24 Octave
Maximum number of blocks	10,000
Octave Analysis Function (OS-0524)	
Number of measurement channels*2	3 to 40 ch (frequency range 25 kHz) 3 to 48 ch (frequency range 20 kHz) (Single / hardware-to-hardware connections)
Octave type	1/1, 1/3, 1/6, 1/12, 1/24 octave (filter : 6th order Butterworth) JIS C 1513-1: 2020 (IEC 61260-1: 2014) class 1 filter JIS C 1514: 2002 class 1
Time constant	None 10 ms 35 ms 125 ms (FAST) 630 ms 1 s (SLOW) 8 s IMPULSE
Analysis frequency range*3	1/1 octave : 1 to 16 kHz (40ch) 1/3 octave : 0.8 to 20 kHz (40ch) 1/6 octave : 0.75 Hz to 21.1 kHz (30ch) 1/12 octave : 0.73 Hz to 21.8 kHz (24ch) 1/24 octave : 0.72 Hz to 22.1 kHz (12ch)
Frequency weighting	A, C, G, Vv, Vh, Vhand user-defined (CSV format)
Displayed calculation values	Instantaneous value, maximum value hold, minimum value hold, average power, total power
Power calculation time	0 to 24 h
Time ratio level calculation function (Lx)	L1, L5, L10, L50, L90, L95, L99
Other functions	Time trend display Channel calculation

Sound Quality Evaluation Function (OS-0525)	
Data type	ISO532-1 Steady-state sounds loudness ISO532-1 Non-steady-state sounds loudness Non-steady-state sounds loudness Roughness Fluctuation strength Tonality Sharpness [DIN45692, Aures, Bismarck] CI (Comfort Index) TNR (Tone-to-Noise Ratio) PR (Prominence Ratio)
Percentile loudness	5 %, 10 %, 95 %
Percentile sharpness	50 %
Sound field	Free, diffuse

Fluctuation Sound Analysis Function (OS-0526)	
Fluctuation sound analysis	
Data type	Fluctuation sound core, fluctuation sound mask, loudness fluctuation core, loudness fluctuation mask
Fluctuation frequency	0.5 to 200 Hz
Overlap	[Specify percentage] 0 % / 25 % / 50 % / 75 % [Specify time] Depends on the lower limit of fluctuation frequency (maximum 3998 ms).
Sound field	Free, diffuse

Fluctuation sound simulator	
Output type	Machining : Removes fluctuating parts. Extraction : Extracts only fluctuating parts
Modulation ratio	0 to 5 times
Fluctuation sound reference value	0 to 1

Time Frequency Analysis Function (OS-0527)	
Short-time Fourier transform	
Frequency resolution	0.001 to 100000 Hz
Window function	Rectangular Hanning Hamming Flat-Top Blackman-Harris
Window function length	512 to 1048576 point
Calculus function	1st derivative, 2nd derivative, single integral, double integral
Frequency weighting	A, C, user-defined (CSV format)

Wavelet transform	
Gabor function	1/3, 1/6, 1/12, 1/24 octave
Analysis frequency range	1 to 12 octaves

Statistical Analysis Function (OS-0531)		
Histogram		
Slice level	Auto scale	-1.797693e+308 to 1.797693e+308
	Specify by division number	2 to 1000000 (10 / 20 / 30 / 40 / 50 / 60 / 70 / 80 / 90 / 100)
	Specify by division size	2 or more
Density calculation	Probability density, cumulative density	

Autocorrelation function		
Number of sampling points	2 to 1000000 (10 / 50 / 100 / 500 / 1000 / 5000)	
Overlap	Percentage	0 to 99 % (90%, 75%, 66.7%, 50%, 25%, 0%)
	Number of samples	Less than sampling points
Max. lag	1 to sampling point / 2 or less	
DC cancel	<input type="radio"/>	
Confidence interval (95 %)	<input type="radio"/>	

Cross-correlation function		
Number of sampling points	2 to 1000000 (10 / 50 / 100 / 500 / 1000 / 5000)	
Overlap	Percentage	0 to 99 % (90%, 75%, 66.7%, 50%, 25%, 0%)
	Number of samples	Less than sampling points
Max. lag	1 to sampling point / 2 or less	
DC cancel	<input type="radio"/>	
Confidence interval (95 %)	<input type="radio"/>	

Scatter plot (regression analysis)		
Regression analysis	Least square method	
Stereogram		
Slice level X-axis	Auto scale	-1.797693e+308 to 1.797693e+308
	Specify by division number	2 to 1000000 (10 / 20 / 30 / 40 / 50 / 60 / 70 / 80 / 90 / 100)
	Specify by division size	Division size of 2 or larger

Slice level Y-axis	Auto scale	-1.797693e+308 to 1.797693e+308
	Specify by division number	2 to 1000000 (10 / 20 / 30 / 40 / 50 / 60 / 70 / 80 / 90 / 100)
	Specify by division size	Division size of 2 or larger

Interval statistics		
Slice level	Auto scale	-1.797693e+308 to 1.797693e+308
	Specify by division number	2 to 1000000 (10 / 20 / 30 / 40 / 50 / 60 / 70 / 80 / 90 / 100)
	Specify by division size	Division size of 2 or larger
Type	Sum, average	

*1: OS-0522 or OS-0524 is required. *2: External input channels are included. When performing 1/N Octave analysis, it is set to 25 kHz.
*3: () is the maximum number of channels when set in measurement mode with a frequency range of 25 kHz.

Product list

Statistical Analysis Function (OS-0531)		
3D interval statistics		
Slice level X-axis	Auto scale	-1.797693e+308 to 1.797693e+308
	Specify by division number	2 to 1000000 (10 / 20 / 30 / 40 / 50 / 60 / 70 / 80 / 90 / 100)
	Specify by division size	Division size of 2 or larger
Slice level Y-axis	Auto scale	-1.797693e+308 to 1.797693e+308
	Specify by division number	2 to 1000000 (10 / 20 / 30 / 40 / 50 / 60 / 70 / 80 / 90 / 100)
	Specify by division size	Division size of 2 or larger
Type	Sum, average	

Video Playback Function (OS-0532)	
Data import format	.avi / .mp4 / .mov / .wmv / .m4a
Supported frame rate	Up to 1000 fps
Max. number of monitors	1 window, 4 screens (up to 2 windows)

Supported Codecs*1		
Extension	Codec	
avi	Video	DV (Digital Video) / Microsoft Video 1 / Motion JPEG / MPEG-4 part 2 / H.263 / H.263+ / H.264/AVC
	Audio	AAC / MP2 / MP3 / PCM
wmv	Video	Windows Media Video 7 / Windows Media Video 8 / Windows Media Video 9 (VC-1)
	Audio	Windows Media Audio 1 / Windows Media Audio 2
mov	Video	Apple ProRes / MPEG-4 part 2 / H.263 / H.263+ / H.264/AVC
	Audio	AAC / ALAC / MP3 / PCM
mp4	Video	AV1 / MPEG-2 video / MPEG-4 part 2 / H.264/AVC / VP8 / VP9 / VC-1
	Audio	AAC / AC-3 / MP3
m4a	Audio	AAC / AC-3 / MP2 / MP3

*1: Some files may not be supported depending on the video format (such as codec and encoding system).

Sound Power Level Using Sound Pressure (OS-0541)*2	
Standards	[Free field, essentially free field over a reflecting plane] ISO 3744: 2025 ISO 3744: 2010 ISO 3745: 2012 ISO 3746: 2010 JIS Z 8732: 2021 JIS Z 8733: 2000 [Reverberation sound field (supported only comparison method)] ISO 3741: 2010, JIS Z 8734: 2021 [High-frequency (supported only broad-band noise without discrete tones)] ISO 9295: 2015
Measurement surface	Hemisphere, parallelepiped, other
Calculation items	A-weighted sound power level L_{WA} Directivity index D_1 Surface sound pressure level non-uniformity index V_1 Time-averaged sound pressure level L_p Range of SPL Background noise correction K_1, K_{1w}, K_{1A} Environmental correction K_2, K_{2A} (Absolute comparison test, direct method, Two-surface method, approximate method) Meteorological correction C_1, C_2, C_3 Difference between background noise and noise source under test $\Delta L_{pr}, \Delta L_{pi}$ Criteria for background noise (relative / absolute)
Analysis frequency range	1/3 octave: 50 Hz to 20 kHz Low frequency range can be expanded to 0.8 Hz*. 1/1 octave: 63 Hz to 16 kHz Low frequency range can be expanded to 1 Hz*. *: only compliant with ISO 3744 and 3745 standards.
Number of channels	1 to 40 channels
Importing file format	DATX
Exporting file format	XLSX (report file) LWDATX (binary file)
Sound pressure level distribution	Supported only hemispherical and parallelepiped measurement surface
Analysis type	[Sound power level based on Standards] Octave analysis (1/1 and 1/3 octave) [Sound power level with the frequency resolution of FFT and instantaneous (reference values) *3] Octave analysis (1/1 and 1/3 octave) FFT analysis FFT tracking analysis (constant width)
Mandatory software	Microsoft® Excel 2016, 2019 or Office 365

*2: OS-0524 is required.

*3: OS-0522 or OS-0523 is required.

Information Technology Equipment Option (OS-0542)*4	
Standards	[Sound power level for information technology and telecommunications equipment] ISO 7779: 2018, JIS X 7779:2012 [Emission sound pressure level] ISO 11201: 2010 [Declared noise emission values] ISO 9296: 2017
Calculation items	A-weighted sound power level L_{WA} A-weighted emission sound pressure level L_{pA} Operator positions (maximum 2 points) Bystander positions (maximum 8 points) Declared noise emission values Declared mean A-weighted sound power level $L_{WA,m}$ Declared mean A-weighted emission sound pressure level $L_{pA,m}$ Statistical adder for verification K_v Prominent discrete tones (TNR, PR) *5

*4: OS-0541 is required.

*5: Same function as TNR and PR in OS-0525.

PC Operation environment	
Common specifications	
Mandatory Interface	LAN terminal 1000base-T, TCP/IPv6
OS	Microsoft® Windows® 10 Pro (64 bit) Microsoft® Windows® 11 Pro (64 bit) Microsoft® Windows® 11 Enterprise LTSC (64 bit) *: Windows 11 Enterprise has been tested and verified to operate correctly in environments using the default configuration (including standard policy settings). We do not guarantee compatibility in environments where default settings have been modified - such as changes to security configurations, group policies, or the use of third-party security software. As a result, support for operation in such customized environments may be limited.
Mandatory software	.NET 8.0 Desktop Runtime (Included in the O-Solution installer)
Optical drive	DVD-R (Used for installation and update.)
Memory	Minimum 16 GB
Storage	• Min. free space 32 GB • When storing data to the external SSD, the port for USB3.2 (Gen1) / USB3.1 (Gen1) / USB3.0 is required.
Display	Minimum 1920x1080

Recommended ① For the measurement / recording with 96 channels or less

CPU	Intel® Core™ processor (Intel® Core™ i7 8th generation or later) 4 cores and 8 threads or more, and 1.8 GHz or more base clock frequency
-----	---

Recommended ② For the measurement / recording with 96 channels or more

CPU	Intel® Core™ processor (Intel® Core™ i7 8th generation or later) 6 cores and 12 threads or more, and 2.5 GHz or more base clock frequency
-----	--

SSDs checked by Ono Sokki

Please refer to our website for the latest information.

Hardware options

Model	Product name
DS-5100	Main unit
DS-0523	3ch 40 kHz input unit
DS-0526	6ch 40 kHz input unit
DS-0532	2ch 100 kHz input unit
DS-0534	4ch 100 kHz input unit
DS-0542	2ch external input unit
DS-0543	2ch external input & 1ch signal output unit
DS-0544	4ch external input unit
DS-0545	2ch signal output unit
DS-0501	Battery unit
DS-0502	Power Supply Interlocking function

Software options

Model	Product name
OS-5100	Plat form
OS-0521	Digital filter function
OS-0522	FFT Analysis function
OS-0523	Tracking Analysis function
OS-0524	Octave Analysis function
OS-0525	Sound Quality Evaluation function
OS-0526	Fluctuation Sound Analysis function
OS-0527	Time Frequency Analysis function
OS-0531	Statistical Analysis Function
OS-0532	Video Playback Function
OS-0541	Sound Power Level Using Sound Pressure
OS-0542	Information Technology Equipment Option
OS-0510	External control for OS-5100
OS-0512	Hardware connection function (/1 unit)
OS-4100	Frequency response measurement software
OS-0410	External control for OS-4100
OT-0450	Loss Factor Calculation Tool for OS-4100

• There are 3 types of license selection: Standalone, Network and USB key (for a fee). Please select according to your purpose or operation environment. Note that the OS-4100 is not licensed.

Set plan

Model	Product name	FFT set	Octave set	Tracking set	SV set
DS-0523	3ch 40 kHz input unit				
DS-0526	6ch 40 kHz input unit				
DS-0532	2ch 100 kHz input unit				
DS-0534	4ch 100 kHz input unit				
DS-5000					
DS-5100	Main unit	●	●	●	●
Select from the above	Input unit	●	●	●	●
DS-0542	2ch external input unit	—	—	●	—
DS-0543	2ch external input & 1ch signal output unit	—	—	—	●
O-Solution					
OS-5100	Plat form	●	●	●	●
OS-0521	Digital filter function	—	—	—	—
OS-0522	FFT Analysis function	●	●	●	●
OS-0523	Tracking Analysis function	—	—	●	●
OS-0524	Octave Analysis function	—	●	—	●
OS-0512	Hardware connection function	●	●	●	●
Model	Product name	Frequency response measurement software & FFT set		Frequency response measurement software set	
DS-5000					
DS-5100	Main unit	●		●	
Select from the above	Input unit	●		●	
DS-0545	2ch signal output unit	●		●	
Software					
OS-5100	Plat form	●		—	
OS-0522	FFT Analysis function	●		—	
OS-0512	Hardware connection function	●		●	
OS-4100	Frequency response measurement software	●		●	
OS-0410	External control for OS-4100	●		●	

- AC adapter and LAN cable for communication are attached to the DS-5100.
- The set plan includes the system assembly fee, but it is required when adding units.

Package plan

Package	FFT pack OS-5120	Sound Quality Evaluation pack OS-5150	Fluctuation Sound Analysis pack OS-5160
Model	License		
OS-5100	●	●	●
OS-0521	●	●	●
OS-0522	●	●	●
OS-0524	—	●	●
OS-0525	—	●	●
OS-0526	—	—	●

* Outer appearance and specifications are subject to change without prior notice. URL: <https://www.onosokki.co.jp/English/english.htm>

ONOSOKKI

WORLDWIDE ONO SOKKI CO., LTD.
12F Yokohama Connect Square 3-3-3 Minatomirai, Nishi-ku, Yokohama 220-0012, Japan
Phone : +81-45-514-2603 Fax : +81-45-935-3808
E-mail : overseas@onosokki.co.jp

U.S.A.
Ono Sokki Technology Inc.
2100 Golf Road, Suite 370
Rolling Meadows, IL 60008, U.S.A.
Phone : +1-630-627-9700
Fax : +1-630-627-0004
E-mail : info@onosokki.net
<https://www.onosokki.net>

THAILAND
Ono Sokki (Thailand) Co., Ltd.
1/293-4 Moo.9 T.Bangphud
A.Pakkred
Nonthaburi 11120, Thailand
Phone : +66-2-584-6735
Fax : +66-2-584-6740
E-mail : sales@onosokki.co.th

INDIA
Ono Sokki India Private Ltd.
Plot No.20, Ground Floor, Sector-3,
IMT Manesar Gurgaon-122050,
Haryana, INDIA
Phone : +91-124-421-1807
Fax : +91-124-421-1809
E-mail : osid@onosokki.co.in

P.R.CHINA
Ono Sokki Shanghai Technology Co., Ltd.
Room 506, No.47 Zhengyi Road, Yangpu
District, Shanghai, 200433, P.R.C.
Phone : +86-21-6503-2656
Fax : +86-21-6506-0327
E-mail : admin@shonosokki.com

