

VIBRATION COMPARATOR

VC-2200 / 3200 Series



VC-2200



VC-3200



There is a wide range of situations in which vibration-based judgments must be made, such as product quality judgment, machinery operation monitoring, facilities diagnosis, and damaged cutting tool detection.

ONO SOKKI caters to all your needs with respect to vibration detection, measurement, and judgment.

ONO SOKKI

VC-2200/3200 Series

The VC-2200 and VC-3200 Vibration Comparators are high-performance digital signal processors that offer three basic functions: detection, measurement, and judgment. The comparators accept signals from accelerometers to detect abnormalities in machines (detection), monitor vibration levels (measurement), and judge vibration levels based on measurements (judgment).

In contrast with conventional measurement devices such as vibrometers, the VC-2200 and VC-3200 can simultaneously process two frequency bands and thus quantify sensory inspection results, which has been difficult previously. Not only for continuous monitoring applications, the comparators can also be used as vibrometers.

*The NP-3331N30 Accelerometer, the NP-0143 Signal Cable (5 m), and the NP-0100 Magnet Base (in the photos) are sold separately.

NP-0143
Signal Cable

NP-3331N30
Accelerometer



NP-0100
Magnet Base

VC-3200 Main unit



VC-2200 Main unit

Condition memory and data memory function

Memory function (VC-3200 only)

Enables to memorize up to 5 judgment conditions depending on each product by means of the condition memory function. The data memory function contributes to store shipping and inspection data.

Extracting necessary information from entire vibration data

Frequency band setting function (Band variable processing function)

Extracting abnormalities specific to workpieces enables accurate level judgment. Two different frequency bands can be set, and rms and peak values can be selected for each band. Simultaneous measurement and judgment is also possible.

Look and judge

Digital display function

In addition to displaying the vibration values digitally, a bar chart provides a visual presentation of the vibration condition, enabling use as needle-indicating vibrometer used in the past. The function allows numerical value management of vibration, and helps quality improvement.

Judgment based on quantitative values

Judgment function (comparator output)

Quantitative judgment is made based on measured values, and a judgment (defective) signal is output. This feature is useful in line inspection and for remote monitoring using PLCs.

Listen and judge

Abnormal sound will alert you

Headphone output

Vibration sound of each specified band can be clearly heard by connecting commercially available headphones. Identification of an abnormal sound, a skilled task, can be performed by inexperienced workers.

Able to perform further analysis

Analog output

AC signal and function DC signal are output simultaneously for each set band, enabling use in combination with analysis equipment such as an FFT analyzer, and connection to a recorder.

Detects necessary information in a timely manner

Comparator gate input

By controlling the measurement timing, it is possible to measure and judge vibrational level of interest. Can be used for automatic Pass/Fail judgment on a production line.

Prevents misjudgment caused by accidental operation

Comparator delay time setting

This feature prevents misoperation caused by human errors, such as when an operator accidentally strikes a sensor. The comparator output is made when the duration of vibration over the comparison level exceeds the specified time.

Ideal for automation and multiple production inspections

RS-232C interface

This feature enables connection to a PC and offers superior extensibility. You can change various setting conditions and collect data via RS-232C.

Easy to install into a control panel

Compact 96 x 96 (DIN) mm size

The VC-2200/3200 are compact design for easy mounting into a control panel. DIN standards are used in many control panels.

TEDS function VC-2200/3200

No more sensor setting errors! Saves you time and effort of measurement preparation!



TEDS key

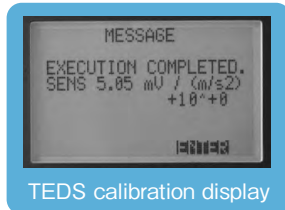

TEDS calibration display

•Photo: VC-2200

Headphone volume MUTE function

VC-2200/3200

Ear protection from an impact noise when mounting a sensor

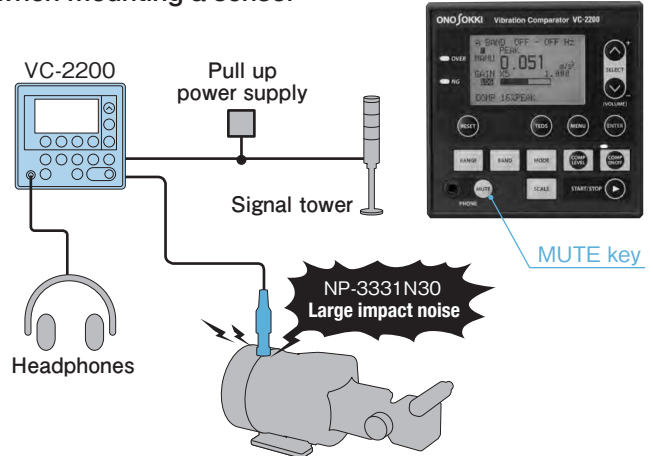

•Photo: VC-2200

Bar chart display function VC-2200/3200
(linear/logarithmic selectable)

Easier-to-read bar chart for small level vibrations!

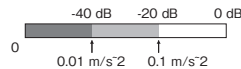
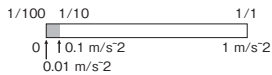
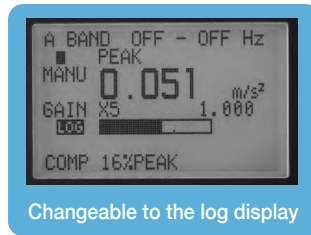
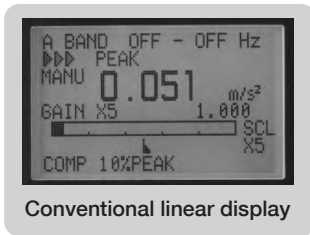

Setting/reading of measurement conditions by one command VC-2200/3200

You can change from one condition setting to another to inspect a different kind of product

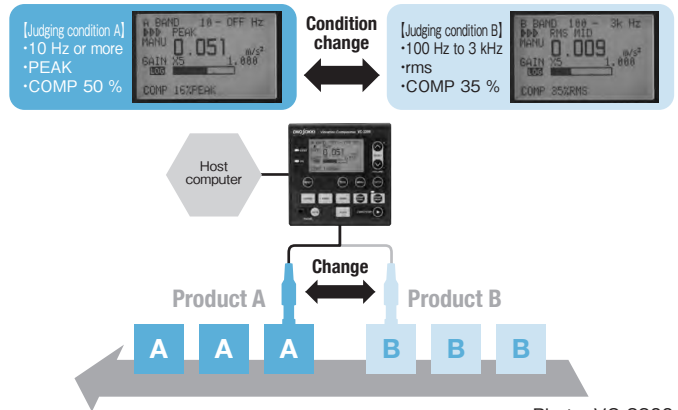

•Photo: VC-2200

Power Average Calculation/Judgment Function

VC-3200

Feature analysis

- Data collection of multiple good products and defective products

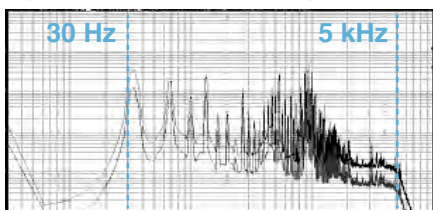

OA value* of good product
0.40 m/s²

OA value* of defective product
1.13 m/s²

Feature extraction using an FFT analyzer (power average calculation)

You need to collect many data of good and defective products which is base of deciding a judgment value so that you can obtain an accurate judgment result.

* Overall value

Determining a judgment condition

- Determining a frequency band for abnormality extraction e.g. 30 Hz to 5 kHz
- Determining a threshold value for judgment e.g. 1.00 m/s²

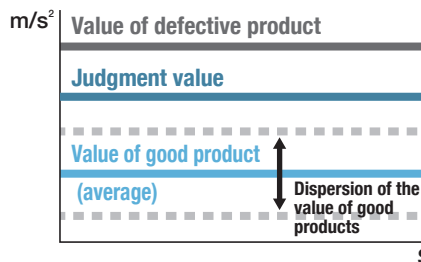

Performance of the judgment

- Judgment using the VC-3200



(Power average judgment)

NG indicator lights up
Comparator signal is output

ISO 2954: 2012 conforming filter

VC-3200

Conforms to ISO 2954: 2012 "Mechanical vibration of rotating and reciprocating machinery"

Why bands?

The frequency band in which vibration occurs depends on the nature of the phenomenon that causes the vibration. The VC-2200/3200 use digital filtering to set the frequency band in which particular types of vibration might occur, thereby enabling independent monitoring and diagnosis for each phenomenon.

Frequency bands A and B are established from f_1 to f_2 and from f_3 to f_4 , respectively, by selecting frequencies f_1 through f_4 . The ability to use a variety of combinations facilitates a detection and measurement strategy that suits the phenomenon being observed. It is also possible to select diagnosis based on either the rms value or the peak value in each band individually.

Frequency distribution of abnormal vibration from rotating machinery

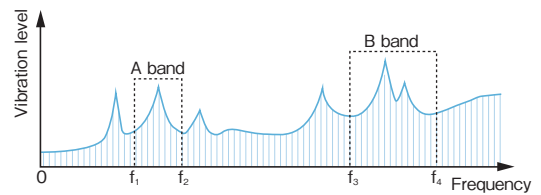

Low-frequency range
 • Imbalance
 • Misalignment, etc.

Intermediate-frequency range
 • Gear meshing vibration
 • Trouble caused by resonance, etc.

High-frequency range
 • Ball bearings vibration
 • Fluid vibration, etc.

* If you need frequency analysis (specification of the frequency), please use an FFT analyzer.

The relationship between vibration parameter and mode

The relationship between band, parameter and mode often used in equipment diagnosis

Band	Frequency range	Parameter	Mode	Example of the abnormal cause	Note
Low frequency	Several to 100 Hz	Displacement*	PEAK (total amplitude)	• Imbalance • Misalignment • Rattle	Related to the amount of displacement or magnitudes of movement
Intermediate frequency	Dozens of Hz to several kHz	Velocity*	RMS	• Wear of bearing	Related to the amount of vibration energy or fatigue
High frequency	1 to 10 kHz	Acceleration	PEAK (half amplitude)	• Flaws of bearing • Flaws of gear	Related to force of impact which causes flaws or defects

* The VC-0423 Integration Software is required for the measurement of displacement and velocity.

Vibration and sense faculties

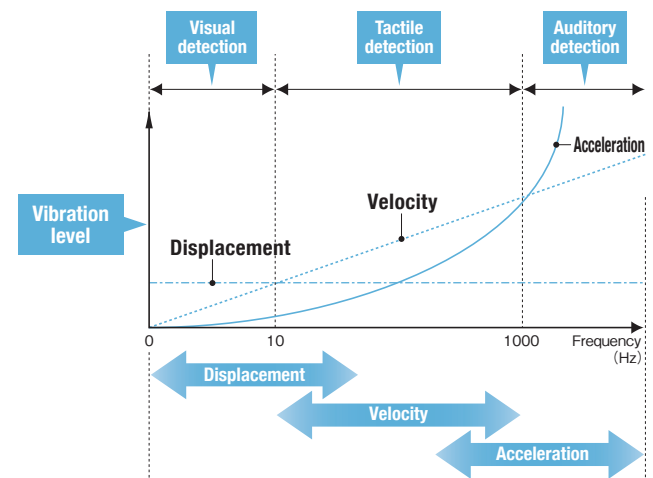

Type of abnormal sound	The amount of displacement or magnitude of movement itself is a problem.	Vibration energy or fatigue level is a problem.	The magnitude of force such as force of impact is a problem.
Measured object	Chattering of machine tools High-speed rotation of flexible shafts	Vibration of ordinary rotating machines Vibration of belt drive equipment	Vibration due to flaws on shaft Vibration due to flaws on gear

What is "the peak/maximum rms value factor" (peak/maximum rms value)?

In order to judge the degree of bearing's flaw, the peak/maximum rms value factor is effective. It is calculated with a peak value/maximum rms value. A vibration value also varies by the sizes of bearing in a peak value or rms value. The peak/maximum rms value factor has the feature which is not influenced by the size of bearing but can measure the degree of a flaw.

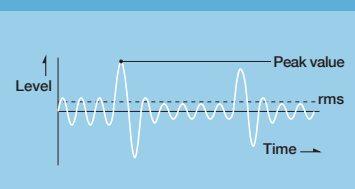

Bearing 1 Good product

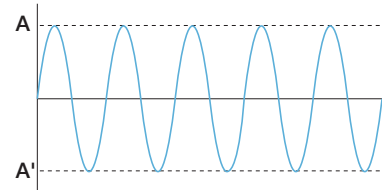
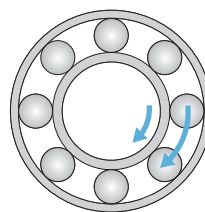

Bearing 2 Defective product

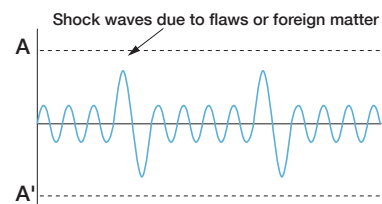
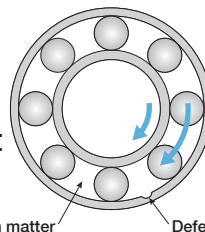

The vibration of bearing 1 has a large amplitude, but is stable (good product). The vibration of bearing 2 has a small amplitude, but shock waves due to flaws or foreign matter are observed (defective product). Since peak and rms values are larger in bearing 1, judgment is not possible in these measurement modes. Judgment based on the peak/maximum rms value factor is effective in such cases.

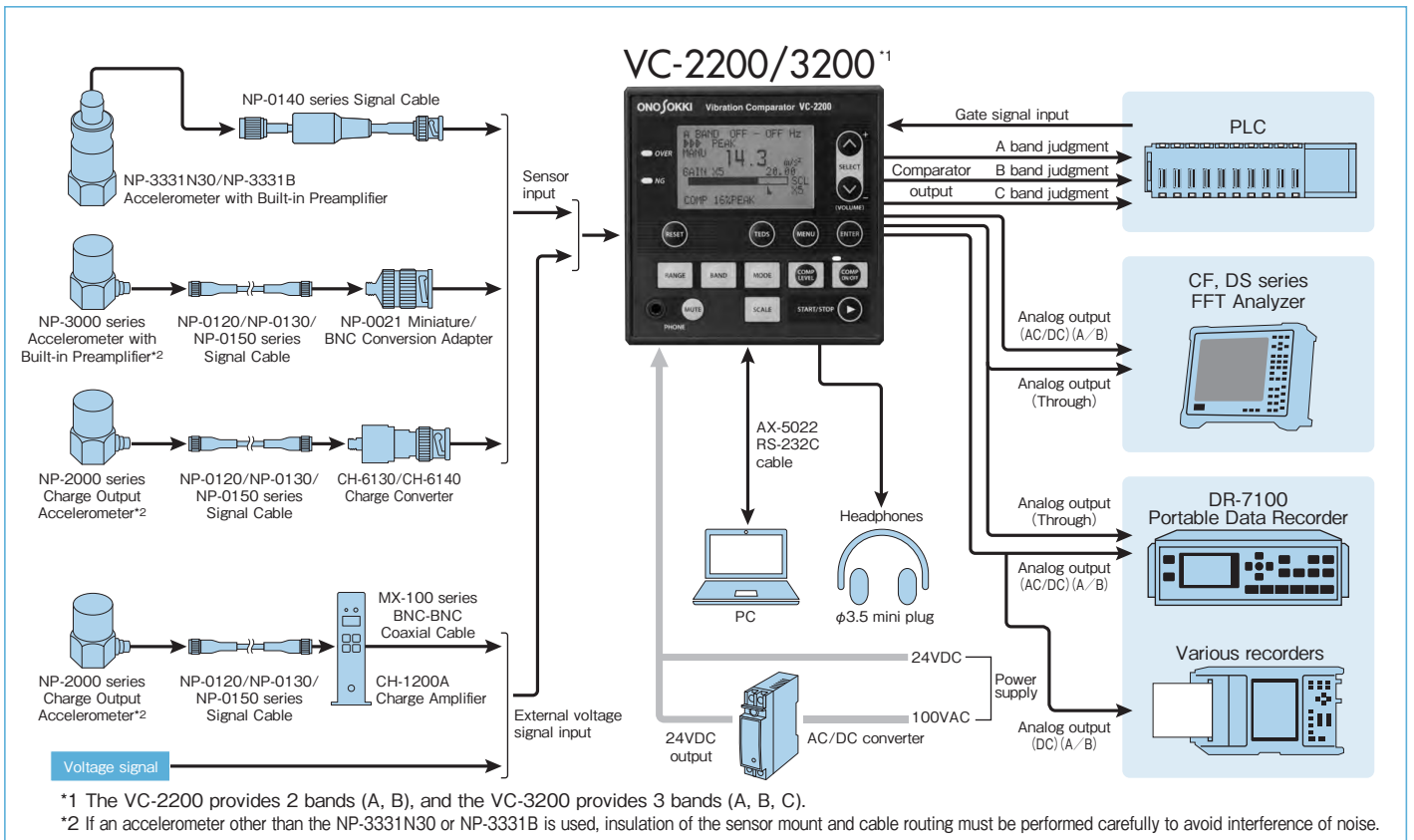

※ Brochures on the NP series, CF series, and DS series are available. Please contact your nearest distributor or contact us at overseas@onosokki.co.jp

Peripherals

VC-2200/3200 Series

Signal Cable for NP-3331N30/ NP-3331B

Model	Length	Appearance
NP-0143	5 m	<p>Please put the rubber cover on the connector when using.</p> <p>Rubber cover</p> <p>Cable diameter φ4.2 mm</p>
NP-0144	10 m	
NP-0146*	20 m	
NP-0148*	30 m	

* made to order.

Miniature/BNC Conversion Adapter

Model	Outer dimensions	Example of use
NP-0021		<p>Connected to VC-2200/3200</p> <p>The sensor input of VC-2200/3200 is a BNC connector. To connect a sensor with a miniature connector to the VC-2200/3200, the NP-0021 is required.</p>

Magnet Base

Model	Outer dimensions	Example of use
NP-0100		<p>Magnet Base for NP-3331N30/ NP-3331B</p>

Accelerometer (sold separately) NP-3331N30 (TEDS)/ NP-3331B



- Feature: Insulated, water-resistance processing*, CE conformity
- Structure: Shear-type
- Sensitivity: 5.0 mV/ (m/s²) ± 10 %
- Resonance frequency: 25 kHz or higher
- Frequency range: 2 Hz to 4 kHz ± 5 %
2 Hz to 10 kHz ± 3 dB
- Lateral sensitivity: 5 % or less
- Max. allowable acceleration: 700 m/s²
- Max. shock resistance: 10,000 m/s²
- Operating temperature range: -20 to +85 °C (NP-3331N30)
-20 to +110 °C (NP-3331B)
- TEDS standard: IEEE1451.4-2004 (Ver.1.0)
- Output impedance: 300 Ω or less (NP-3331N30)
100 Ω or less (NP-3331B)
- Detector noise: 20 μVrms or less
- Power requirement: 0.5 to 5 mA
- Weight: Approx. 50 g
- Case material: Stainless (SUS303)
- Outer dimensions: 17Hex × 37.5H (mm)
- Connector: TNC connector (from top)
- Detector mounting: M5, depth 5, female thread

* For the water-resistance modification (IPX7: equivalent) additional charge is required.

Signal Cable (sold separately) NP-0140 series

- Operating temperature range: -20 to +110 °C
- Cable outer diameter: φ4.2 mm
- Material: FEP/PUR (black)
- Waterproof rubber cover: NBR
- Sensor connector: TNC
- Amplifier connector: C02 (BNC)
- Cable length: 5, 10, 20, 30 m

Features

Total Support for Detection, Measurement, and Diagnosis

"Band variable processing function" detects bearing damage and wear in a single pass.

Actual size

Compact size DIN 96×96 mm

2-band judgment function is packed into this compact size body.

RS-232C interface

Enables to connect to the PC and allows extension.

Superb diagnosis capability using rms and peak values

The rms and peak values can be used for diagnosis in each band individually, enabling enhanced precision diagnosis of complex machine vibrations.

TEDS key

Avoids errors of sensor sensitivity setting and reduces labor during sensor replacement.

Verification of vibration sound

By connecting commercially available headphones, it is possible to monitor the vibration sound. An output of the vibration sound for each band is provided enabling verification of particular vibration phenomena.



Digital and bar chart display of vibration values

High-accuracy analysis is performed in accordance with analysis conditions, and vibration values and vibration condition are displayed (bar chart display). By displaying measurement screens for each band separately, you can select the display screen that you want to see.

A band measurement screen

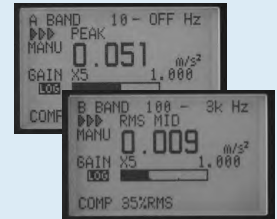

B band measurement screen

Judgment result screen

COMP DATA	
COMP FUNC	DATA
A - PEAK	0.463 m/s ²
B NG RMS	0.359 m/s ²

Provides essential sophisticated features

Measurement and diagnosis of vibration is a complex process, and demands highly precise results. The VC-2200/3200 provide high-level precision and detailed conditions settings, to meet other tough measurement and diagnosis requirements.

Easy operation ————— direct keys

Frequently used conditions can be directly set, enabling the optimum settings to be made while observing the vibration condition.

- Measurement mode selection: RMS, PEAK, MAX HOLD (maximum rms value hold), and PEAK HOLD (peak value hold)
- Measurement screen switching and band setting ● Comparator level setting: Setting is possible to suit a diagnosis criterion.
- Bar chart scale change ● Input range setting: optimum range setting to suit the vibration condition

Outer dimensions (unit: mm)

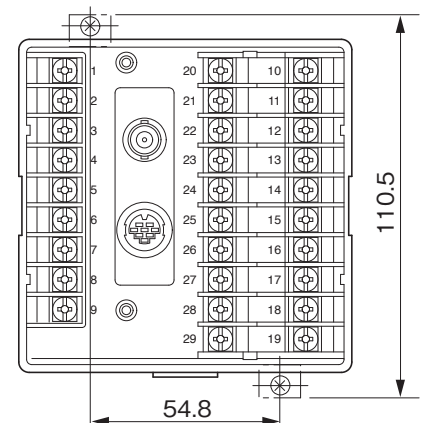
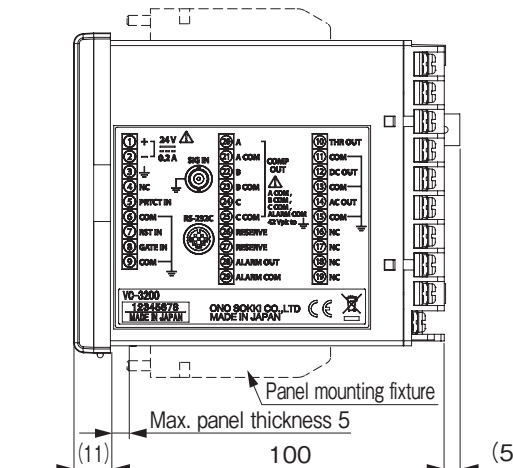
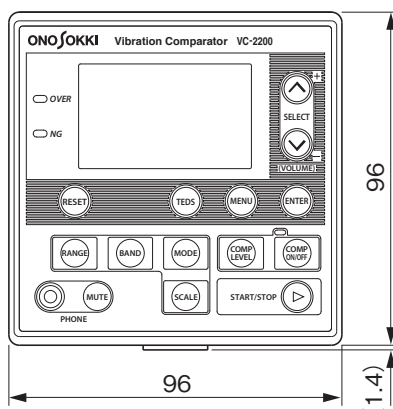

• Terminal block: M3.5 screw with square washer

Automated Data Collection Made Easier

Wiring diagram (VC-2200)

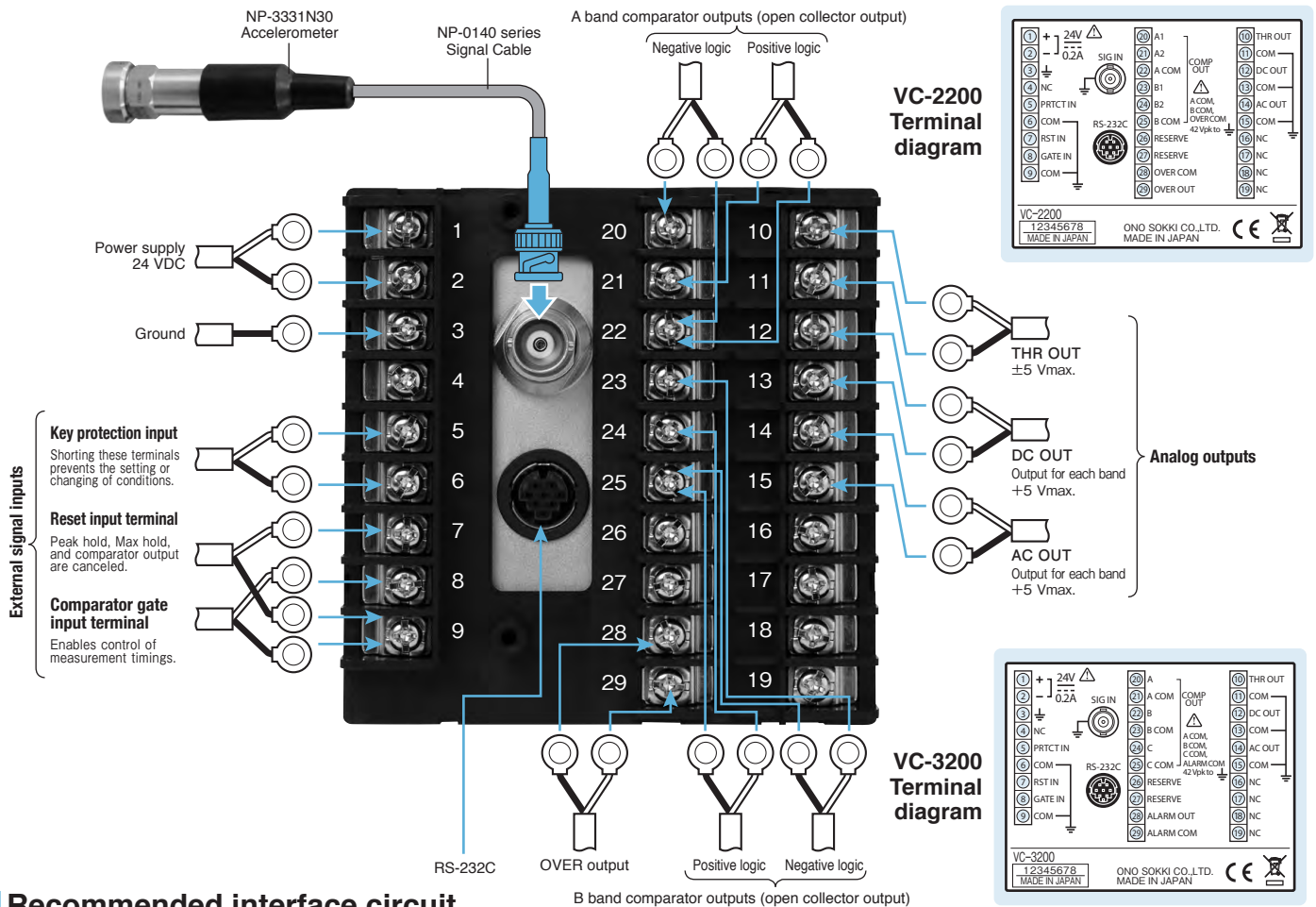

Recommended interface circuit

External signal input

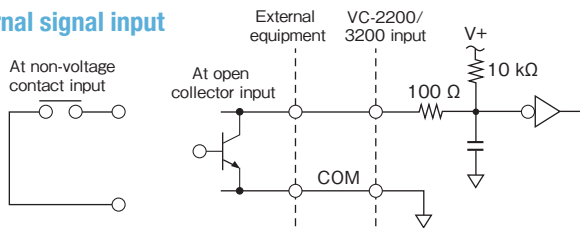

Comparator output

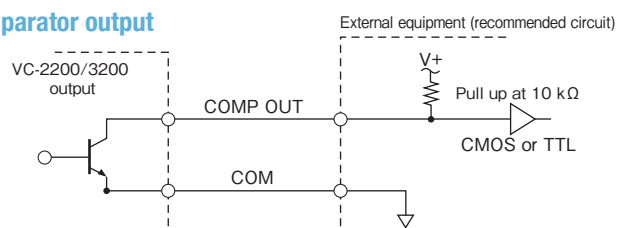

NP-3331N30 / NP-3331B Outer dimensions (unit: mm) (Sold separately)

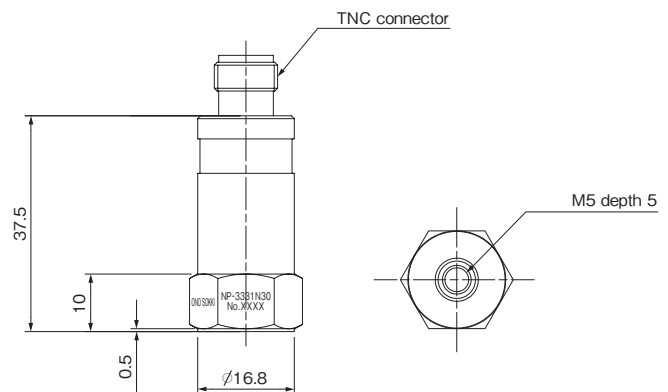
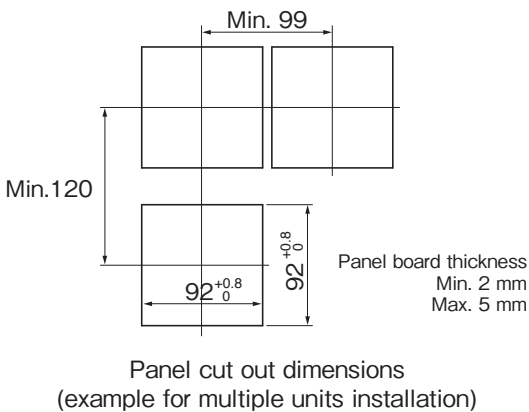

Product inspection

In shipping inspection of products, sensory inspections by operators such as touching with hands and listening for abnormal sounds are often used for making judgments. However, these types of inspections suffer from variability in quality, higher labor costs, and lack of quantitative values, leading to different judgments among inspectors. As a result, the entire lot must be replaced when a defect is found. The VC-2200 and VC-3200 enable quantitative judgment, thus improving product quality and reducing labor cost.

Inspection of motors before delivery (inspection of abnormality)

The VC-2200/3200 enable automatic inspection of products by replacing the sensory inspection (especially for the listening check) by operators. Can make Pass/Fail judgment by overall vibration value of motor as well as detecting the problem of internal bearings by specifying and taking measures of the frequency band which leads to the abnormality.

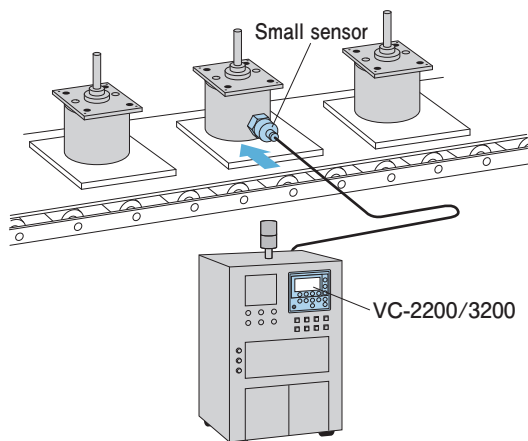

Inspection of pumps before delivery (inspection of rattling/abnormal sound)

As an inspection of pumps or the like before delivery, visual checking by vibrometer and listening check using stethoscopic probe are popular. The VC-2200/3200 enable automatic inspection according to the numerical values. Also enable to make Pass/Fail judgment by overall vibration values (velocity and displacement) of the pump as well as inspection of the wrong assembly of internal bearings.

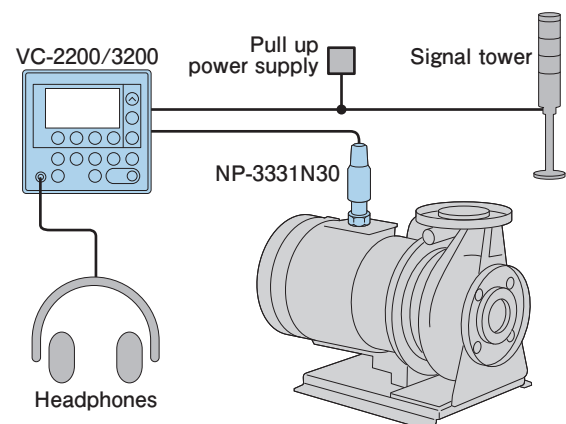

Inspection of compressor (inspection of abnormal sound)

As an inspection of abnormal sound from compressor, listening check by operator is popular. You could choose another method using sound level meter as it is an inspection of abnormal sound, but it requires enough space and much cost for an anechoic box in order to reduce the influence of the background noise. As an alternative to these methods, the inspection which is focused on the vibration is performed. Processing the band-limited frequency allows the detection of abnormal sound and automatic determination.

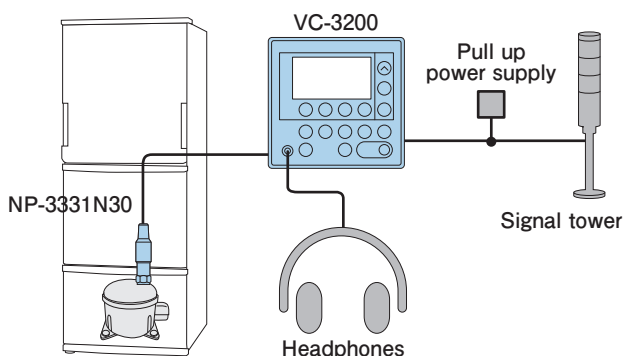

Inspection of chipped resin gear teeth

This example shows how to detect the damages (deformation, flaws) to resin gear teeth and foreign objects trapped inside the equipment which are used for audio visual systems and office automation apparatus. This system using the VC-2200/3200 vibration comparator allows quantification of the abnormalities and automatic determination, instead of the listening check by operators. Also it ensures that all products are inspected for consistent quality on production line.

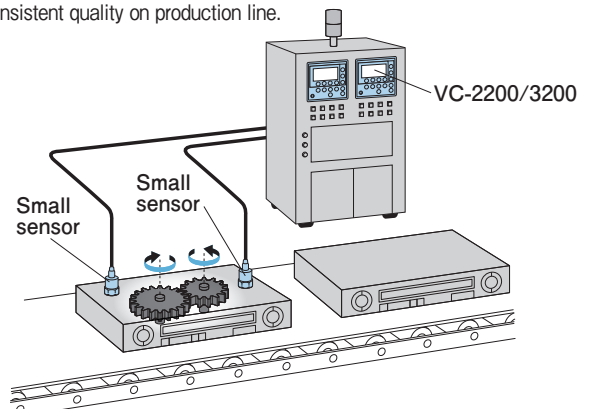

Inspection of a nick on gear boxes

As an inspection whether there is a nick or not on the gear box, sensory test by operators (touching with hand, listening the difference with stethoscopic probe) is popular. This way of inspection cannot avoid human-error and variation in quality. The determination by quantitative value is necessary in order to improve the quality and stable supply of product. The VC-3200 can detect whether there is a nick or not on the product and make determination by quantitative value.

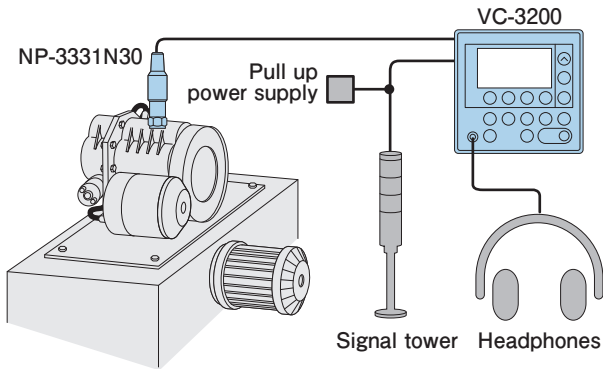

Detecting nicks on a gear at the inspection before delivery

This example shows how to detect the nick on a gear using the VC-3200 vibration comparator. Pass/Fail judgment is made by the difference of vibration values. You can take numeral control while checking the vibration sound through headphones.

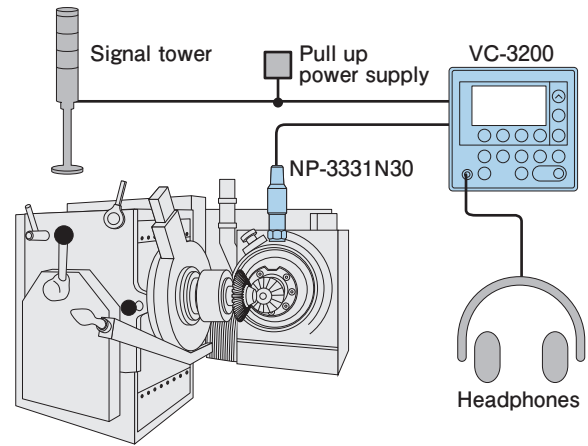

Inspection of engines before delivery (Inspection of knocking / abnormal sound)

One of the inspection items before delivery for engines is checking for abnormal sound. There are many factors that may cause an abnormal sound including imbalance of components, electrical sound, and knocking. Currently, this inspection is typically performed by operators listening with a stethoscopic probe. Since acoustic judgment for abnormal sounds using a microphone is difficult in some work environments, a vibration-based detection method using a vibration comparator is becoming popular. This method enables quantitative judgment through detection and level judgment using band-pass filters. It also allows acoustic inspection through headphone output, which facilitates comparison with the conventional inspection method to check if level judgment is made by actually detecting abnormal sound.

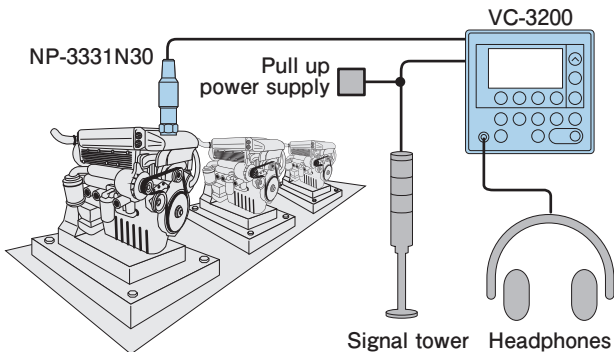

Detection of abnormal sound of steering pumps

Abnormal sound during steering wheel operation may be caused by the steering pump or vibration of rubbing parts. Inspection before delivery is normally performed by operators installing the pump on a jig and listening to the sound generated by turning the steering wheel. The VC-3200 detects abnormal sounds using vibrations from a sensor attached to the workpiece. Detecting the required vibration with band-pass filters for level judgment allows quantitative judgment, which helps to achieve stable product quality. Since there is a specific timing of abnormal sound due to the structure of the pump, the measurement timing is controlled using gate signals.

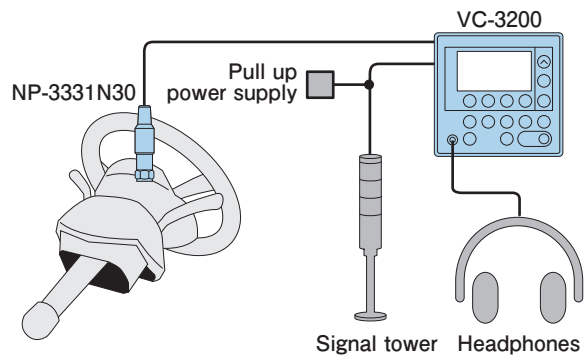

Detection of abnormal sound from actuators for side mirror

The cause of abnormal sound from actuators for side mirror might be a deformation or missing of the resin gear teeth, grease with foreign material or motor itself. The VC-2200/3200 can be used for these inspections.

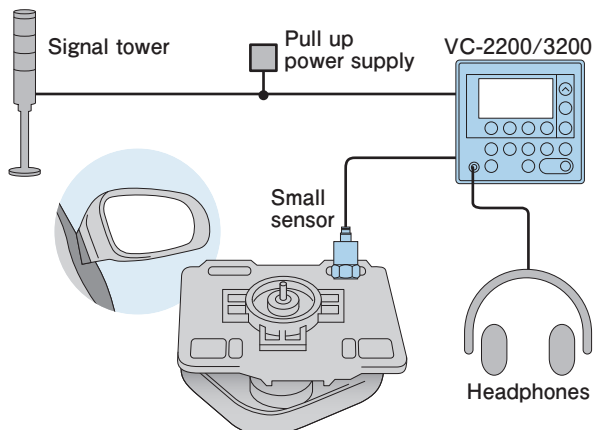

Inspection of rattling from washing machines

The vibration from washing machines greatly affects the product value. For an inspection of vibration, they use equipment such as sensors or vibrometers; however, the determination is made by operators with visual check. In this example, the VC-0423 Integration Software (option) enables direct reading of the amplitude value and automatic determination. It contributes to the cost reduction and stable quality.

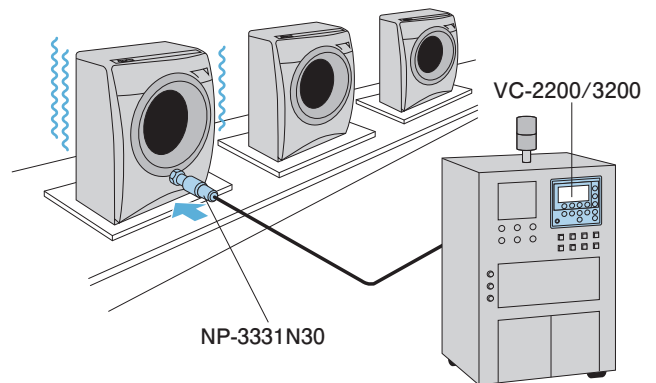

Inspection of rice cookers before delivery

In this example, the VC-2200/3200 detects the vibration of pressure adjustment valve in rice cookers for the operation check. In a conventional inspection method, operators have to listen carefully the abnormality from operated sound of the pressure adjustment valve. The determination by vibration value drastically reduces the strain on operator's ears and the time for inspection process. The Pass/Fail judgment is made by the difference of vibration value. The control by value and checking of vibration sound by headphones can be performed at the same time.

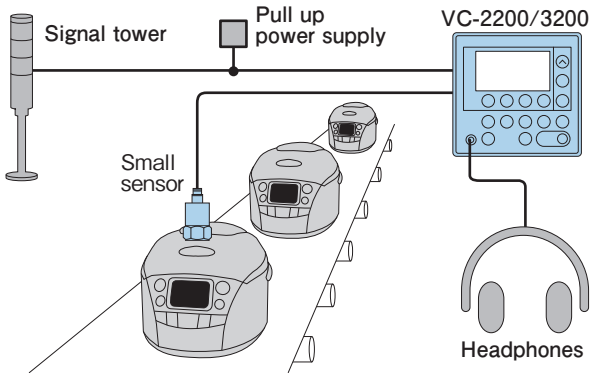

Detection of cracks in products during the press process

Inspection of cracks in pressed products is normally done by operators after the press process. If a defect is found in an inspection after the process, the products in the entire lot may have to be rejected. In addition, visual inspection of a huge number of products takes time and effort, and so operators may overlook during checking. Since overlooking cracks in this process greatly affects the quality of the subsequent products, it is important to detect cracks during the process and to prevent the outflow of detectors. The VC-3200 detects vibrations generated from a crack and makes a Pass/Fail judgment, thus improving process efficiency and preventing products with cracks from processing to a later processes.

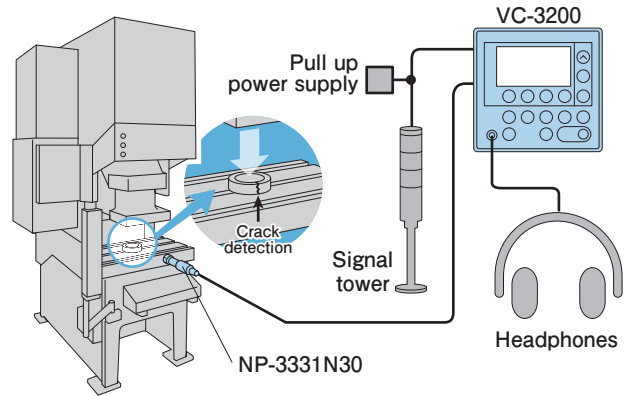

Detection of abnormal sound from camcorders or digital cameras

Abnormal sound from camcorders or digital cameras may be caused by a built-in motor, damaged gears, foreign material, or an operation section etc. In the inspection of products before delivery, operators actually operate products and inspect by listening. You could choose another method using a microphone as it is an inspection of abnormal sound, but it requires enough space and much cost for sound insulating box to reduce the influence of the back ground noise. The VC-3200 can capture these components of abnormal sound and make determination by quantitative value.

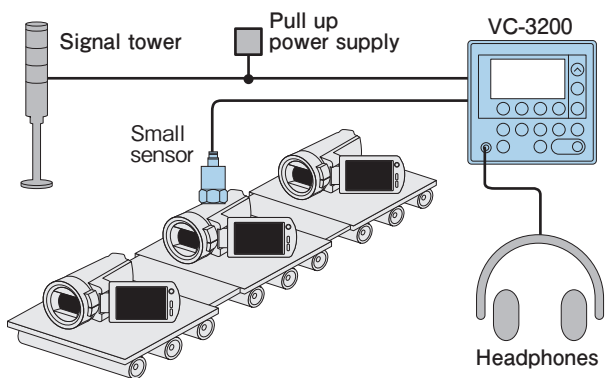

Inspection of bearings before delivery

At an inspection of bearings before delivery, scratch, foreign material and rattling from inside of bearings by bad installation are inspected. The figure below shows an example of the inspection using the VC-2200/3200. The VC-2200/3200 can detect smaller scratch assuredly by measuring peak/maximum rms value factor in addition to peak and rms values.

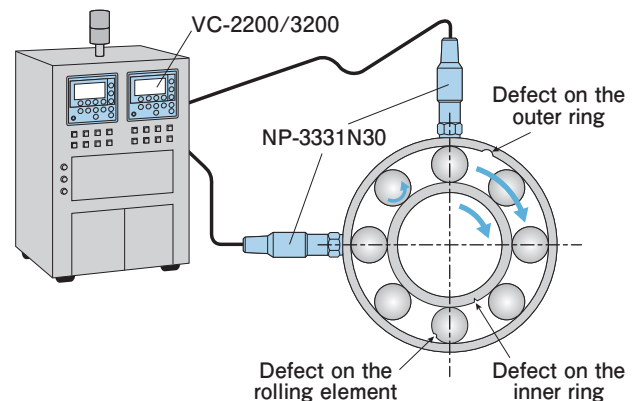

Inspection of small fans before delivery

Inspection of small fans before delivery is mostly performed in the form of sensory inspection by operators. Judgment of rattling and abnormal sounds at the rated rotation speed is dependent on the operators' sense. In recent years, quantitative judgment has become necessary to achieve stable product quality, particularly as manufacturing plants have been transferred overseas. The illustration below shows a sample setup of attaching sensors in the radial and thrust directions of a fan to detect rattling and abnormal sounds for level judgment. There are two methods of attaching sensors to a fan: pressing the sensors against the fan using a jig or installing them on a jig in advance. The latter method detects vibrations transferred to the jig, which is used when it is difficult to build a mechanism to press the sensors against the workpiece.

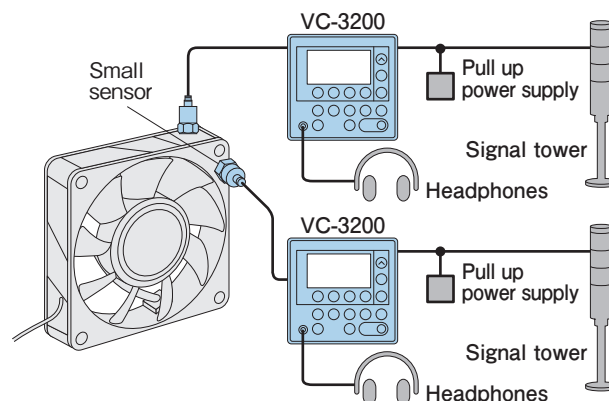

Monitoring for abnormal machine operations

Abnormal vibrations (such as chattering of machines) during machining processes greatly affect the accuracy of finished products. If an abnormal vibration occurs in an endurance test of products, the testing equipment must be stopped immediately to prevent serious damage. It is therefore important to monitor the operation of the equipment and to stop it when an abnormal operation occurs.

The VC-2200 and 3200 allow monitoring of abnormal operation. They also enable the testing equipment to be emergency-stopped by using comparator output in the event of abnormal operation.

Endurance test of engines

When an abnormal vibration is generated during a knocking test or an endurance test of engines, the operation must be stopped. In particular, an abnormal vibration in unattended operation or unexpected abnormality might cause serious damage of system etc. Therefore, monitoring vibrations is necessary to avoid that kind of accident. This application enables control of machinery by constantly monitoring vibrations in unattended operation. For example, the VC-3200 outputs NG signal to bring an emergency stop of operation when abnormal vibration is generated.

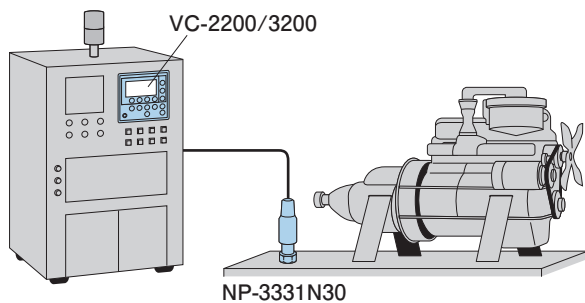

Endurance test of hub unit (bearing)

The endurance test of a bearing is conducted by applying a load to the bearing which is rotated for a long period of time. Damage inspection is performed either by removing the bearing after a certain period of operation and visually checking for damage, or through judgment based on the sound and vibration during operation. However, these tests mostly consist of unattended operation, and the testing equipment may be damaged if an abnormality in the bearing is not noticed. The VC-3200 allows bearing vibrations to be monitored at all times. If an abnormal vibration occurs, it outputs an NG signal, enabling the testing equipment to be emergency-stopped, for example.

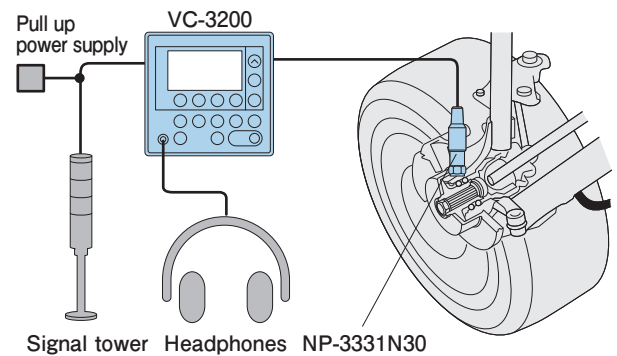

Endurance test for a transmission (gear)

For a transmission, endurance test is necessary because of its hard usage. The endurance test is performed under high load over long operation. As damage of gear or bearing can lead to destruction of tester, abnormality must be detected to stop system urgently. The VC-3200 enables control of machinery such as an emergency stop by constantly monitoring vibration from bearing and outputs NG signal when abnormal vibration is generated.

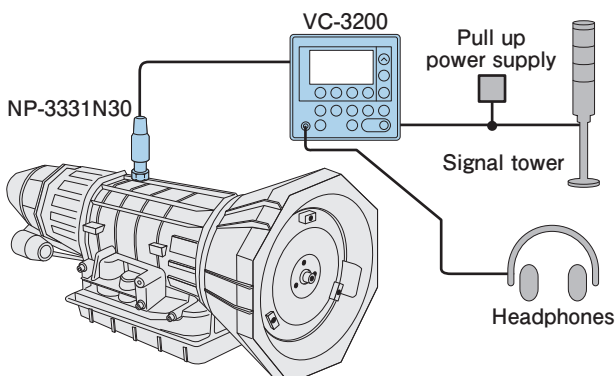

Monitoring for abnormal vibrations during gear machining process

Abnormal vibrations generated during gear machining are a major cause of defects. The vibrations may be caused by worn or chipped cutters or failure of the machine itself. Machined gears are inspected visually by operators or by using dedicated equipment. However, 100% inspection by these methods takes much time and effort. The VC-3200 can simultaneously monitor abnormalities in rotation of first order (rattling of the machine) and abnormalities due to damaged cutters (vibrations in the high-frequency range) by using band-pass filters. This prevents defective products from being produced and going to the subsequent processes, and also facilitates 100% inspection, thus greatly improving quality and reducing labor cost.

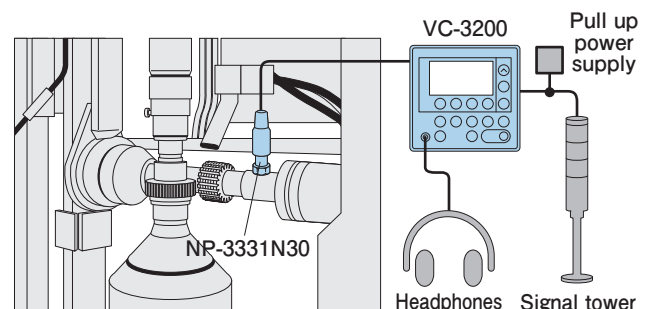

Monitoring for abnormal vibrations during production process of a liquid crystal cell (monitor)

Liquid crystal cell is produced with delicate work from forming polarity to injection of liquid crystal. Vibrations during a production process affects on product quality. Though yield rate greatly affects on production cost, you cannot know performance of product until you actually power it on at the time of final inspection in many cases. The VC-2200/3200 detect and determine vibrations during a production process. This application helps to prevent NG product or its outflow and to contribute stable quality.

VC-2200/3200

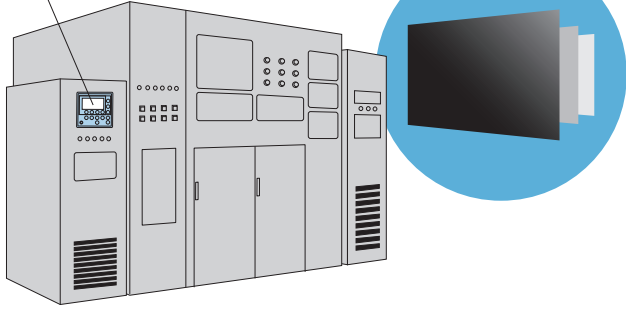

Monitoring a sieve operation (chemical plant)

When powder is sifted through a sieve, the sieve vibrates at smaller amplitude if it is clogged. However, a sieve vibrates at larger amplitude if there is any abnormality in a way of installing equipment or motor. With the VC-2200/3200, you can constantly monitor the sieve whether the vibrations are in normal range.

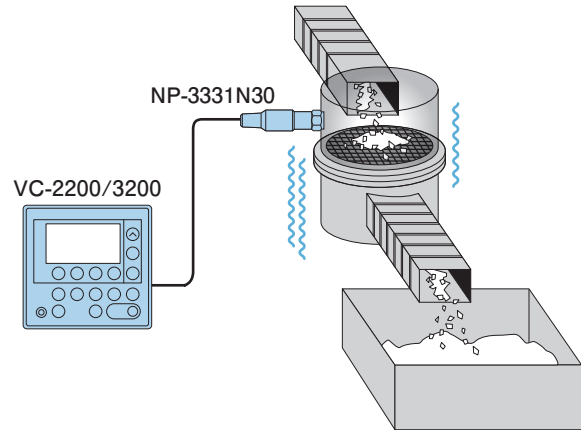

Monitoring for abnormal vibrations of a wafer carrier system

At semiconductor plant, abnormal vibrations during carrying conveyance between processes or in-process lead to damage of wafer in the conveyance. This application including the VC-2200/3200 monitors vibrations which are generated during carrying a conveyance and enables control such as stopping the carrying. It also can be used for monitoring of vibrations other than carrying such as detecting crack of wafer in each process.

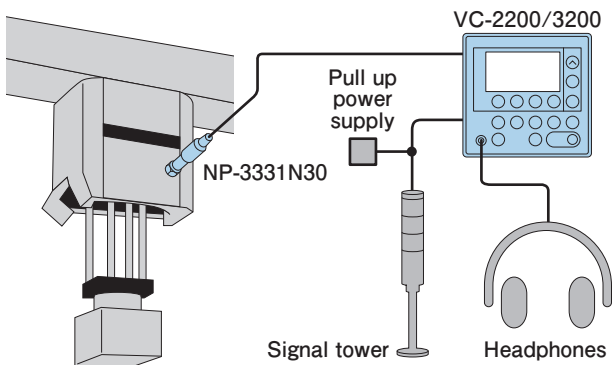

Detection of fin-breaking in a diffuser

Diffuser is operated for 24 hours and used in a severe condition. In particular, fin-breaking will lead to a serious accident. In this example, the VC-3200 constantly monitors the equipment, and it is helpful for predictive maintenance by detecting an abnormal vibration earlier such as prevention from an accident caused for wear. This application is promising on early detection in emergency situation including unexpected fin-breaking.

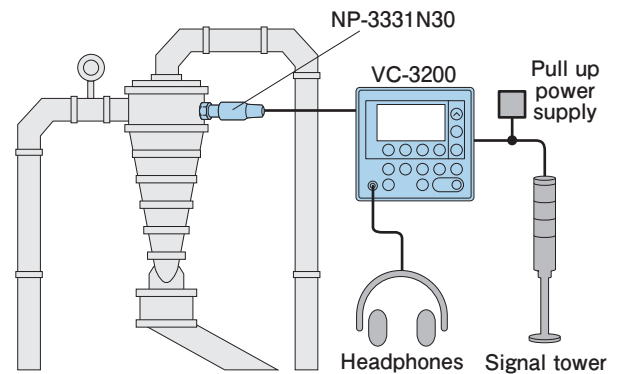

Detection of a cracked material during torsional testing

To evaluate tolerance of material against torsion, a torsion tester is used. This example shows how to detect cracks on material by vibration. The vibration sensor is mounted on around a bearing of chuck (stationary side). The difference of frequency band between vibration in rotor rotation and vibration from cracked material can be used for monitoring of vibration by using the band variable processing function of the VC-3200.

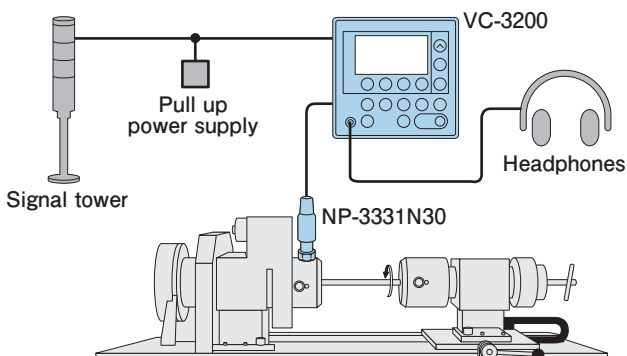

Inspection of interference between grinding stone and carrier in silicon wafer grinding process

In the silicon wafer grinding process, interference between the carrier and grinding stone may occur, causing damage to the carrier. Since the repair of damaged carriers is very expensive, it is important to detect this interference. Normally, the grinding process is controlled by time. The process may finish before the set schedule due to variability among the parts, resulting in grinding further than necessary and causing interference with the carrier. By continuously monitoring for vibrations using the VC-3200, interference between the carrier and grinding stone can be detected and damage prevented.

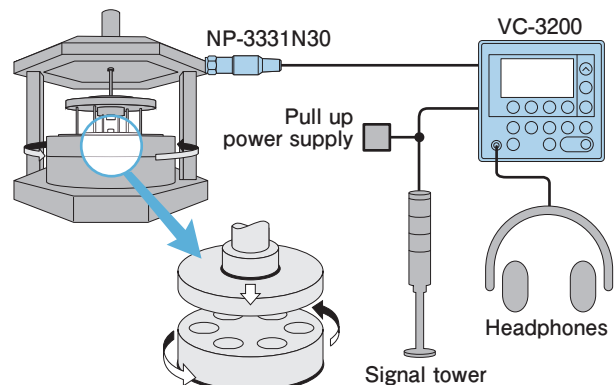

Facility Monitoring

Monitoring vibration to detect abnormality of bearings, gears and other parts of production facilities without attendance. Facility diagnosis used to take a lot of work and time. Operators must measure and keep watching vibration from the facilities (bearing box, etc.) because the vibration change gives an indication to know the timing of parts replacement or even abnormality. Moreover, unexpected abnormality may cause the serious breakage of the facilities. The VC-2200 and VC-3200 can continuously monitor vibrations to detect unusual movement, prevent them from serious breakage and save the labor. The frequency band can be specified that might indicate the abnormality.

Monitoring vibrations of motors and pumps

This example shows continuous monitoring of a motor in equipment. In this case, parts such as bearings in the equipment used to be replaced early to prevent accidents such as production line interruption. Periodical inspection using a vibrometer also incurred a high cost and required much labor. By using the VC-3200, it is possible to accurately determine the parts replacement time, thus saving time. The comparator also plays an important role in preventing accidents caused by sudden failures thanks to its ability to detect abnormality of the equipment and wear of parts based on changes in vibration values. Value-based management and vibration sound checking using headphones can be done simultaneously.

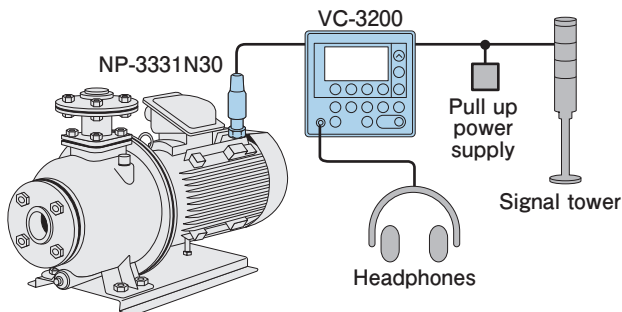

Monitoring vibrations from rolling mills

This example shows how to perform constant monitoring of a rolling mill. Periodical control by operators cannot avoid unexpected abnormality. This application helps to prevent that kind of accident by detecting abnormality immediately. They can be set up externally and used in small/medium monitoring system.

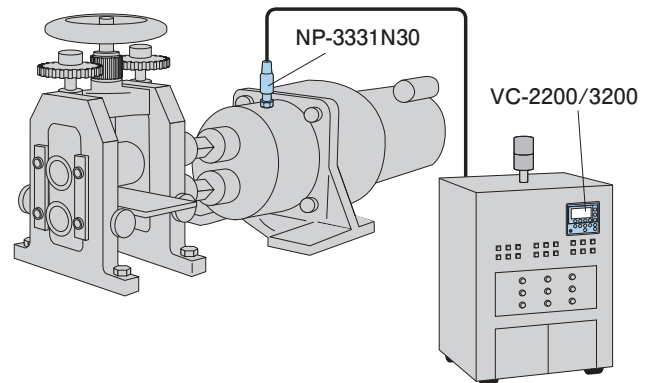

Monitoring vibrations from broken runner vane/corn of water-wheel (dam)

When a water-wheel, which is a heart of hydropower generation, is broken, it causes decrease in power generation efficiency as well as breakage in other parts. Early detection of abnormality and maintenance are important. As abrasion or breakage appears in abnormal vibrations, monitoring vibrations is an effective way to detect abnormality. The VC-3200 vibration comparator can monitor vibrations periodically, detect abnormal vibrations and output alarm signal. This application is helpful for predictive maintenance such as prevention of an accident.

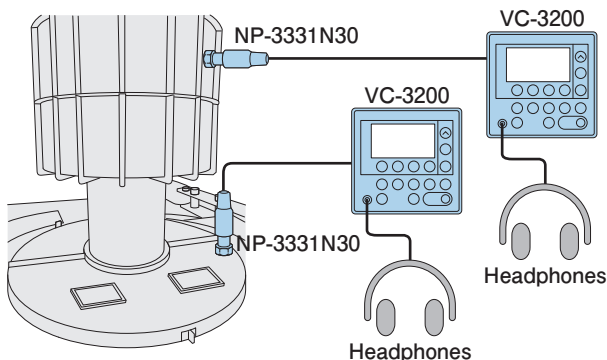

Monitoring for abnormality in main shaft of machine tool

Deterioration of a bearing that supports the main shaft of a machine tool significantly affects the accuracy of parts machining. Even if maintenance such as greasing the bearing is conducted periodically, the deterioration time largely depends on the frequency of use. By using the VC-3200 to monitor the vibration of the main shaft, failures in the bearing can be detected in the early stages. Since bearing failures may not be accurately detected during machining due to vibrations in cutting operation, monitoring is performed at specific timings when the machine is running at idle.

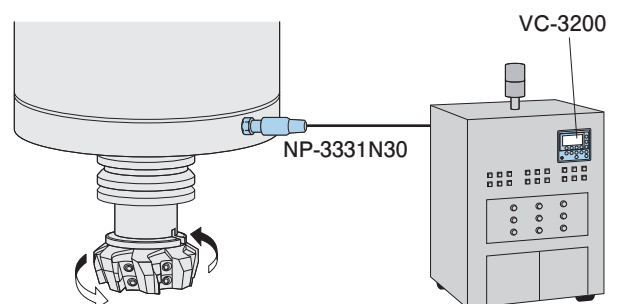

Detection of broken or worn machine tools

Detects drill bit break, tool bit break etc. of operating machine tool without attendance. For the machines which process quite a large quantity of parts, such as NC machine, unattended operation is employed. If the drill bit or other tool is broken during unattended operation, it causes defective products. Reprocessing or disposal of these defective products is nothing but waste of money. The VC-2200 and VC-3200 detect vibrations when the drill bit is broken and make stop the operation if occurred, as a result, minimize producing defectives. Worn drill bit also lowers processing accuracy. Monitoring vibration change and checking the operation help to improve the processing accuracy.

Detection of broken or worn drills

This example shows how to monitor a drill of machine tool constantly to detect defect (breakage or chip etc.). This application can reduce defective products and improve product quality.

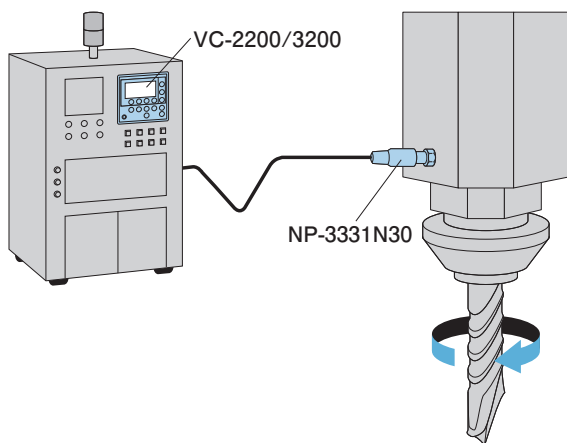

Detection of wear of grinding wheels

In parts grinding processes, wear of grinding wheels is one of the factors that reduces the accuracy of finished products. Currently, the maintenance of grinding wheels is based on the number and period of machining operations, so even good cutters are subject to periodic inspection. On the other hand, if abnormal wear occurs for some unknown reason, defective parts may be produced. Users typically want to effectively use cutters until the end of their service life to reduce cost. The VC-2200/3200 can detect imbalance caused by wear based on vibrations, which helps to improve product quality and reduce costs.

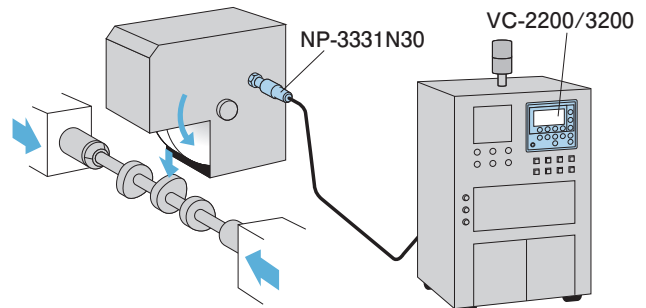

Detection of broken blades of textile cutting machines

If a cutter blade is broken, all textile of the lot should be thrown away because the broken cutter blade may be remained in a textile. Detecting a breakage of cutter blade is indispensable to prevent such a large loss. Today, metal detector or the like monitors whether a broken edge is mixed in textile or not. The VC-3200 detects abnormal vibration to find breakage of a cutter blade. This application gives an alert with signal tower when it detects the breakage.

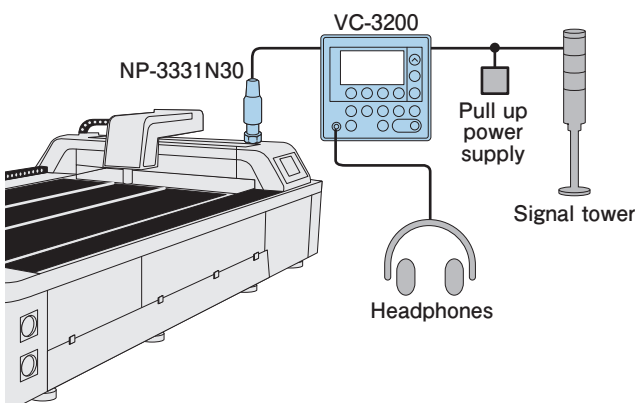

Detection of chip during fillet roll processing

The engine's crank shaft is the heart of an engine, and its strength depends on fillet roll processing. Chipping during the fillet roll processing has not only a big influence on the product's quality (rattling or other abnormal sounds etc.) but may also cause defects. The VC-2200/3200 detect abnormalities during fillet roll processing. The band variable processing function of the VC-2200/3200 is useful for detecting the impact vibration of chipping during processing.

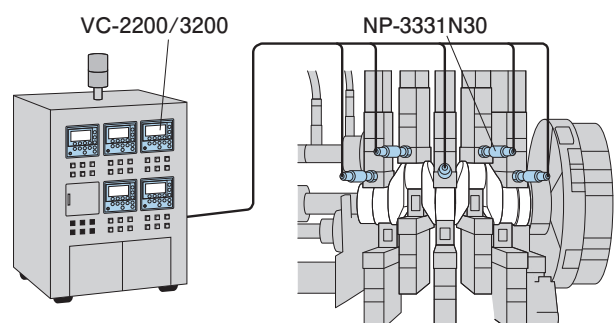

<Input Section>

The number of input channels : 1
 Signal input : Switched between an accelerometer with built-in preamplifier and an external voltage signal.
 • Accelerometer with built-in preamplifier: sensor power supply CCLD (constant current) 4mA +24VDC
 NP-3331B, NP-3331N20 (TEDS applicable, discontinued product), NP-3331N30 (TEDS applicable) (CCLD: a sensor interface using constant current supply)
 • External voltage signal: Input voltage ±5 V, input impedance 100 kΩ ±0.5 %
 • Input connector: C02 (BNC)

	VC-2200	VC-3200
Cable disconnection detection function	Cable disconnection can be detected when using CCLD. *LCD display only	Cable disconnection can be detected and open collector (positive) signal is output when using CCLD. *Common to over output (selectable)

TEDS function : Accepts accelerometers conforming to IEEE1451.4-2004 Ver.1.0
 If a TEDS supported sensor made by other companies is used, TEDS information may not be read according to the type of a TEDS chip included in a sensor. If you are considering the purchase of a TEDS sensor made by other companies, please consult to the manufacturer or dealer of the TEDS sensor, and perform the operation check. When you want to use a TEDS sensor you already have with the TEDS supported measurement instruments which was made by Ono Sokki, please perform the operation check with a demonstration product of Ono Sokki.

Sensor sensitivity setting : 1.00×10E-2 to 9.99×10E+2 mV/ (m/s²)
 Unit setting : Selectable between m/s² or EU
 Input range : Settable Input range: 0.1 to 50,000 m/s² (Setting range varies depending on the sensor sensitivity.)
 Frequency characteristics : 1.5 Hz to 20 kHz ±3 dB, 3 Hz to 15 kHz ±0.5 dB (reference frequency: 160 Hz)
 Dynamic range : 80 dB or more (input voltage range ×1, ×2, ×5)
 70 dB or more (input voltage range ×10, ×20, ×50, ×100, ×200, ×500)

<External Control>

Terminal block input : Key protect, reset, gate
 Voltage input (high: 5.0 to 2.4 V, low: 0.8 to 0 V) or non-voltage input (open circuit voltage: 5 V, short circuit current: 0.5 mA or less)
 RS-232C : Measurement and judgment conditions can be set individually or in a batch.

	VC-2200	VC-3200
Transmission rate	9,600 bps	9,600/19,200 bps
	• Connector: DIN 8-pin circular connector compatible with HR12-10R-8 SD (by HIROSE ELECTRIC CO., LTD.) • Recommended cable: AX-5022 (9-pin D-sub connector)	

<Analysis Section>

	VC-2200	VC-3200
The number of bands	2	3
Band filter	HPF: OFF/100 Hz/300 Hz/500 Hz/1 kHz/3 kHz/5 kHz/10 kHz LPF: OFF/100 Hz/300 Hz/500 Hz/1 kHz/3 kHz/5 kHz/10 kHz	HPF: OFF/50 Hz/100 Hz/200 Hz/300 Hz/500 Hz/1 kHz/2 kHz/3 kHz/5 kHz/10 kHz LPF: OFF/50 Hz/100 Hz/200 Hz/300 Hz/500 Hz/1 kHz/2 kHz/3 kHz/5 kHz/10 kHz
	(-48 dB/oct Butterworth characteristics -3 dB ± 1 dB at fc)	
Analog filter	Low cut (High-pass filter): 10 Hz High cut (Low-pass filter): 1 kHz, 10 kHz -3 dB±1 dB, -18 dB/oct at fc	Low cut (High-pass filter): 3 Hz, 10 Hz High cut (Low-pass filter): 1 kHz, 10 kHz -3 dB±1 dB, -18 dB/oct at fc

(Note) fc: cutoff frequency

*Both 10 Hz (Low cut) and 1 kHz (High cut) conform to ISO2954-2012 (VC-3200 only)

<Processing Section>

	VC-2200	VC-3200
Measurement mode	Can display results respectively for each measured band. (Selectable from below) • Root mean square value RMS: root mean square value Time constant: 125 ms/250 ms/1 s (selectable) • Peak value PEAK: Absolute peak value of time waveforms • MAX hold Holds maximum rms value • Peak hold Holds maximum peak value	Can display results respectively for each measured band. (Selectable from below) • Root mean square value RMS: root mean square value Time constant: 8 ms/16 ms/32 ms/63ms/125 ms/250 ms/500 ms/1 s (selectable) • Peak value PEAK: Absolute peak value of time waveforms • Peak/maximum rms value factor PRF*1: peak value ÷ maximum rms value • MAX hold Holds maximum rms value • Peak hold Holds maximum peak value • Peak/maximum rms value factor hold PRF HOLD: holds maximum value of peak/maximum rms value factor • Power average*2 $PAVG: \sqrt{\frac{1}{T} \int_0^T X(t)^2 dt}$ Average time: OFF/100 ms/200 ms/300 ms/500 ms/1 s/2 s/3 s/5 s/10 s/20 s (selectable) *1 PRF: Peak/maximum rms value factor *2 During the power average is set, other measurement mode cannot be set in all bands.
Other averaging function		Tactmax value TAVG: displays maximum value in 500 ms. The number of times of average processing: OFF/4/8/16/32/64 times (selectable)

<Output Section>

Analog output : THR (through)/AC/DC simultaneous output (AC/DC: select the output of each band)
 • Output impedance : approx. 50 Ω
 • THR (through) : max. output: ±5 V
 Frequency range : 1.5 Hz to 40 kHz ±3 dB
 3 Hz to 15 kHz ±0.5 dB
 • AC output : max. rated output: ±5 V
 Frequency range : 1.5 Hz to 20 kHz ±3 dB
 3 Hz to 15 kHz ±0.5 dB
 • DC output : selectable output for each band (rms value).
 Max. rated output: +5 V
 • Accuracy of analog output : ±3 %/FS (at 160 Hz)
 Headphone output : AC output for each band
 • Max. output : 15 mW or more
 • Rated impedance : 24 Ω
 • Connector : φ3.5 stereo mini-jack
 CAL signal output : Outputs 160 Hz, 1 V_{OP} ±3 % from THR/AC output terminal.

<Output Section>

	VC-2200	VC-3200
Over output	Outputs when input range over and A/D over Open collector output (positive logic)	Outputs when input range over and A/D over Open collector output (positive logic) •Shared with cable disconnection detection output. (selectable)
	•Max. applied voltage: 30 VDC (between OVER OUT and OVER COM) •Max. sink current: 25 mA •Insulation withstand voltage: 42 VDC (between OVER COM and FG)	•Max. applied voltage: 30 VDC (between ALARM OUT and ALARM COM) •Max. sink current: 25 mA •Insulation withstand voltage: 42 VDC (between ALARM COM and FG)

<Comparator Output>

Function	: Independent judgment for each band	
	VC-2200	VC-3200
	Capable of making judgment of rms value/peak value for each band.	Capable of making judgment of rms value, peak value, and peak/maximum rms value factor for each band. When making judgment of power average, the power average judgment is made in all bands.
Comparator level setting	: 0 to 100 % of the full scale range (in 1 % steps)	
NG output	: Outputs when setup value or over/setup value or under	
	VC-2200	VC-3200
	Open collector output (Outputs positive and negative logic simultaneously)	Open collector output (Setup selectable from positive and negative logic)
	Max. applied voltage: 30 VDC (between A-ACOM/B-BCOM/ C-CCOM) •Max. sink current: 25mA •Insulation withstand voltage: 42 VDC (between ACOM-FG/BCOM-FG/CCOM-FG)	
Response time	: 100 ms or less	
Delay time setting	: Selectable from 0/0.5/1/1.5/2/3/4/5/6/7/8/9/10/15/20 (seconds)	

<Display Section>

Display	: LCD with backlight •Measurement value display: 4-digit digital display (update time: 0.5 seconds) •Bar chart indicator: selectable from linear/logarithmic display (update time: 0.1 seconds) •Comparator level display
OVER indicator	: Lights in red when input range over or calculation over occurs.
NG indicator	: Lights in red in the case of comparator NG output.
Comparator ON/OFF indicator	: Lights in green while comparator is active.

<Others>

Condition backup	: Capable of preserving setting values while the power supply is off. (VC-2200)
Condition memory	: Up to five conditions can be saved. (VC-3200)
Data memory	: Capable of storing the data of up to 500 measurement values for each condition. (judgment result data only) (VC-3200)

<General Specifications>

Power supply voltage	: 24 VDC ±10 %
Current consumption	: 0.2 A or less
Insulation resistance	: Between power supply +/- terminals and grounding terminal: 10 MΩ or more (at 500 VDC megger)
Withstand voltage	: Between power supply +/- terminals and grounding terminal: 350 VAC (for one min.)
Vibration resistance	: 19.6 m/s ² (frequency 10 to 150 Hz, 150 Hz, XYZ directions)
Impact resistance	: 392 m/s ² (reaction time 13 ms)
Operating temperature and humidity range	: 0 to +55 °C, 85 % RH or less (with no condensation)
Storage temperature and humidity range	: -5 to +55 °C, 85 % RH or less (with no condensation)
Outer dimensions	: DIN 96(W)×96(H)×112(D) mm (Excluding projections)
Weight	: Approx. 500 g
Housing material	: 94V0 PBT (Polybutylene terephthalate)
CE marking	: Conforming (EMC Directive, Low Voltage Directive, and RoHS Directive)

<Accessories>

Panel mounting fixtures (2 pcs.), instruction manual, and quick reference manual
--

Product Lineup

VC-2200/3200 Series

Main unit

Model	Product name
VC-2200	Vibration Comparator
VC-3200	High Function Vibration Comparator

Option

Model	Product name	VC-2200	VC-3200
VC-0321	Low Frequency Band-pass Filter	—	○
VC-0322	Intermediate Frequency Band-pass Filter	—	○
VC-0323	High Frequency Band-pass Filter	—	○
VC-0423	Integration Software	○	○

○ : option available — : not supported

Signal Cable for NP-3331N30/NP-3331B

Model	Length	Model	Length
NP-0143	5 m	NP-0146	20 m
NP-0144	10 m	NP-0148	30 m

Detector

Model	Product name
NP-3331N30	Accelerometer with Built-in Preamp (TEDS applicable)
NP-3331B	Accelerometer with Built-in Preamp

Others

Model	Product name
NP-0021	Miniature/BNC Conversion Adapter
NP-0100	Magnet Base
AX-5022	RS-232C Signal Cable 2 m (for PC connection)
VC-0352	AC/DC Converter Set

ONOSOKKI

WORLDWIDE ONO SOKKI CO., LTD.

1-16-1 Hakusan, Midori-ku, Yokohama, 226-8507, Japan
Phone : +81-45-935-3918 Fax : +81-45-930-1808
E-mail : overseas@onosokki.co.jp

*Outer appearance and specifications are subject to change without prior notice.

URL : <https://www.onosokki.co.jp/English/english.htm>

U.S.A.

Ono Sokki Technology Inc.
2171 Executive Drive, Suite 400,
Addison, IL 60101, U.S.A.
Phone : +1-630-627-9700
Fax : +1-630-627-0004
E-mail : info@onosokki.net
http://www.onosokki.net

THAILAND

Ono Sokki (Thailand) Co., Ltd.
1/293-4 Moo.9 T.Bangphud
A.Pakkred,
Nonthaburi 11120, Thailand
Phone : +66-2-584-6735
Fax : +66-2-584-6740
E-mail : sales@onosokki.co.th

INDIA

Ono Sokki India Private Ltd.
Plot No.20, Ground Floor, Sector-3,
IMT Manesar Gurgaon-122050,
Haryana, INDIA
Phone : +91-124-421-1807
Fax : +91-124-421-1809
E-mail : osid@onosokki.co.in

P.R.CHINA

Ono Sokki Shanghai Technology Co., Ltd.
Room 506, No.47 Zhengyi Road, Yangpu
District, Shanghai, 200433, P.R.C.
Phone : +86-21-6503-2656
Fax : +86-21-6506-0327
E-mail : admin@shonosokki.com