

LC-8300A

GPS Speedometer

ONOSOKKI

Uninterrupted measurements
at proving grounds and urban areas



LC-8300A GPS Speedometer

The flagship model developed by ONO SOKKI, a pioneer of speedometers

The LC-8300A is a speedometer that combines the features of existing models with light weight, compact size, and high accuracy. It enables stable speed measurement regardless of the test environment, even in urban areas where radio interference is likely to occur due to trees and buildings. Equipped with the various test functions that comply with regulations, it supports a wide range of vehicle test.



Test without a PC

Flexible measurement according to test conditions and installation space

It is a bit troublesome to install and operate a PC on a vehicle in the actual vehicle test. However, the LC-8300A enables tests without a PC, and it can be connected to a PC to test from an app as well as the existing models.

Standalone Test Mode (PC-less)

A simple configuration consisting of only the LC-8300A GPS speedometer and peripherals. Settings such as test conditions are performed on the touch panel display. Test results are recorded in the built-in storage or USB memory (CSV format). After the test is completed, the data can be transferred to a PC and showed on a graph using application software.



Test results examples

Touch panel display

MFDD TEST		State	Memory Usage
		13	57%
		N8	Internal
V0	: 190.7 km/h	Sb	: 120.72 m
Time	: 5.58 s	Se	: 175.10 m
HD	: 176.82 m	CVO	: --- km/h
MFDD	: 16.264	CD	: m
Vb	: 152.6 km/h	Ve	: km/h

Recorded data example (MFDD mode)

HARD TEST	
Mode	MFDD
Date	2023/3/11
Local Time	15:58:47
Precision	OK
H.Distance	77.67 m
V:D	121.33 km/h
MFDD	7.949
Vb	96.82 km/h
Ve	12.05 km/h
Sb	32.03 m
Se	76.81 m
Corrected Calc. Mode	OFF

PC Test Mode

Perform various tests and measurements from the app. Test results are saved on a PC.* After setting the detailed conditions in the application software, remove a USB cable and perform the test without a PC (Standalone Test Mode).

*When the PC Test mode is activated, the touch panel display is disabled.



LC-8000 series
Application Software

*A PC is prepared by a customer.

Test results examples

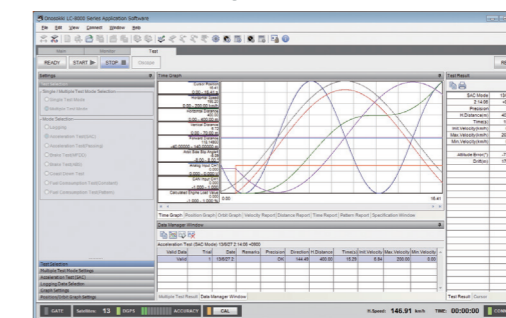

Velocity Report

Velocity (km/h)	Distance (m)	Time (s)	Alt (m)	ACC (m/s²)	Heading (°)	Roll (°)	Pitch (°)	Yaw (°)	Roll Rate (°/s)	Pitch Rate (°/s)	Yaw Rate (°/s)
1.44	0.00	0.00	0.00	0.00	172.81	0.0	0.0	0.0	0.0	0.0	0.0
10.00	0.88	0.88	0.46	0.31	162.85	0.0	0.0	0.0	0.0	0.0	0.0
20.00	1.86	0.98	0.20	0.10	157.87	0.0	0.0	0.0	0.0	0.0	0.0
30.00	2.83	1.00	0.24	0.13	148.90	0.0	0.0	0.0	0.0	0.0	0.0
40.00	3.80	1.01	0.27	0.15	139.93	0.0	0.0	0.0	0.0	0.0	0.0
50.00	4.78	1.02	0.30	0.17	130.96	0.0	0.0	0.0	0.0	0.0	0.0
60.00	5.75	1.03	0.33	0.19	121.99	0.0	0.0	0.0	0.0	0.0	0.0
70.00	6.73	1.04	0.36	0.21	113.02	0.0	0.0	0.0	0.0	0.0	0.0
80.00	7.70	1.05	0.39	0.23	104.05	0.0	0.0	0.0	0.0	0.0	0.0
90.00	8.68	1.06	0.42	0.25	95.08	0.0	0.0	0.0	0.0	0.0	0.0
100.00	9.65	1.07	0.45	0.27	86.11	0.0	0.0	0.0	0.0	0.0	0.0
110.00	10.63	1.08	0.48	0.29	77.14	0.0	0.0	0.0	0.0	0.0	0.0
120.00	11.60	1.09	0.51	0.31	68.17	0.0	0.0	0.0	0.0	0.0	0.0
130.00	12.58	1.10	0.54	0.33	59.20	0.0	0.0	0.0	0.0	0.0	0.0
140.00	13.55	1.11	0.57	0.35	50.23	0.0	0.0	0.0	0.0	0.0	0.0
150.00	14.53	1.12	0.60	0.37	41.26	0.0	0.0	0.0	0.0	0.0	0.0
160.00	15.50	1.13	0.63	0.39	32.29	0.0	0.0	0.0	0.0	0.0	0.0
170.00	16.48	1.14	0.66	0.41	23.32	0.0	0.0	0.0	0.0	0.0	0.0
180.00	17.45	1.15	0.69	0.43	14.35	0.0	0.0	0.0	0.0	0.0	0.0
190.00	18.43	1.16	0.72	0.45	5.38	0.0	0.0	0.0	0.0	0.0	0.0
200.00	19.40	1.17	0.75	0.47	-3.59	0.0	0.0	0.0	0.0	0.0	0.0

Drifting value measurement
(LC-0833 Orbit Display Software used)

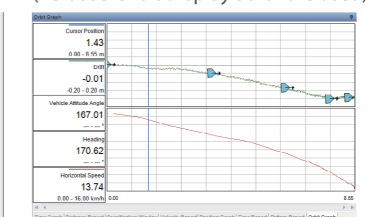

Features

Stable measurement

Achieves outstanding stability

Improved satellite acquisition performance

Adopts a highly sensitive GPS/GLONASS receiver that is four times more sensitive than the existing models. As a result, the satellite acquisition performance has been greatly improved, and there is no need to worry about satellite acquisition being interrupted during measurement.

GPS supported by IMU correction

By using not only the velocity information from GPS but also correcting by IMU, the stable measurement is realized even in environments where radio wave reception is unstable.

In addition, even if the satellite acquisition condition is good, the velocity correction is constantly performed by the IMU. Thus, it is possible to output velocity data very accurately compared to using a GPS alone.

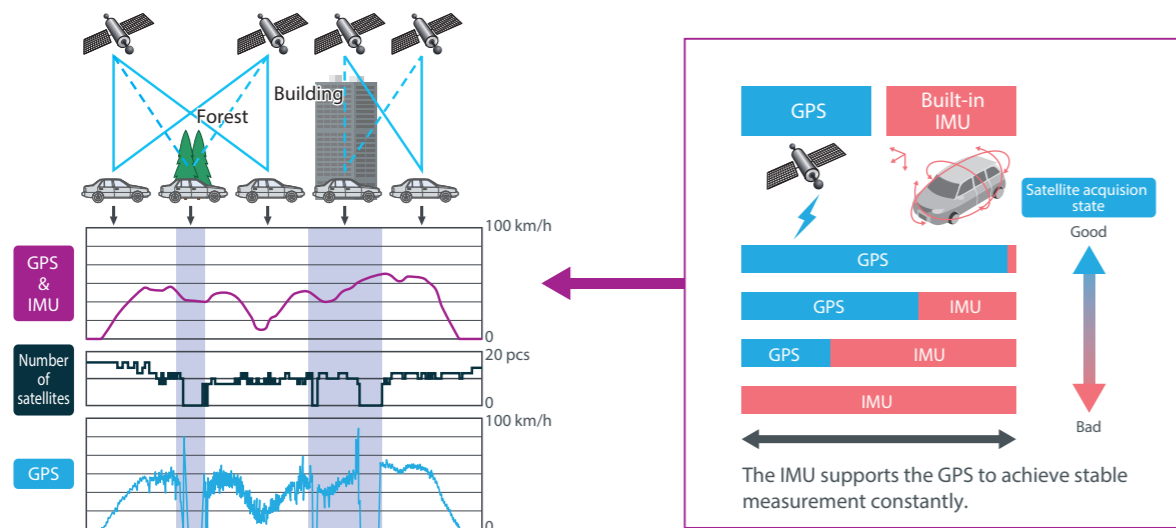

With only a GPS, the measurement cannot be performed under the shadow of trees or a bridge. Velocity waveforms are generally unstable and rough.

* The above figure is an image of satellite acquisition and correction by IMU. We do not guarantee the accuracy of our products or the number of satellites captured.

Expanding application scenes

For a wide range of test needs

The GPS antenna can be installed on the roof of or inside the vehicle.* It can be used for a wide range of test needs, such as running resistance performance.

*Depending on the vehicle type and driving environment, the number of satellites captured may decrease and the measurement may become unstable.

*For tests that require high accuracy of horizontal distance and that perform sudden acceleration/deceleration, install the antenna on the roof.

As the bottom of the antenna is a magnet, it can be attached directly to the vehicle roof.

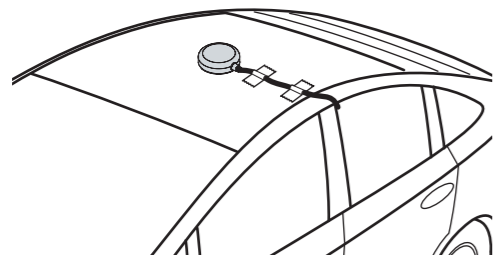

Antenna installed on the roof

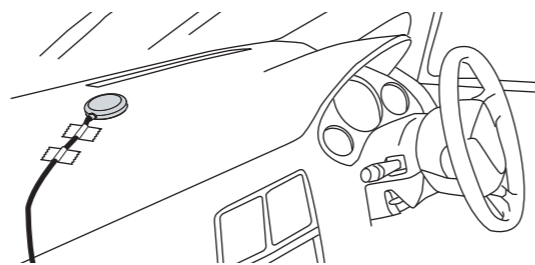

Antenna installed on the instrument panel

Expanding application scenes

Stable measurements can be performed without worrying about satellite loss, not only in open spaces such as proving grounds, but also in urban areas where radio interference is likely to occur due to trees and buildings and under overpasses. Also, when the vehicle is stopped, such as waiting at a traffic light, the speed display stops just at 0 km/h.

* Depending on driving environment, the number of satellites captured may decrease and the measurement may become unstable.



Continuous measurement even when passing under an overpass



During stopping at a traffic light, the speed display stops just at 0 km/h.

Perfect for such test scenes

- **Noise test**
Not affected by wind noise
- **Actual driving test**
Not conspicuous appearance
- **Coasting test**
Air resistance does not increase
- **Test under bad weather***
Test in rain or snow

* The antenna has a protection class of IP67, thus it can be installed on the vehicle even in bad weather.

High response even in sudden acceleration, sudden braking

High responsiveness is achieved by the correction function using IMU. Stable and accurate measurement is also achieved by our original algorithm. It is ideal for tests that require accuracy of transient response such as acceleration tests, braking tests, and steering stability.

Analysis result image Sudden braking (50→0 km/h)

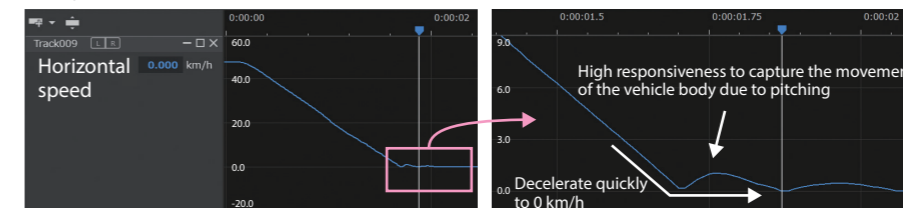

Analysis result image Tipi-in-Tipi-out* (10↔40 km/h)

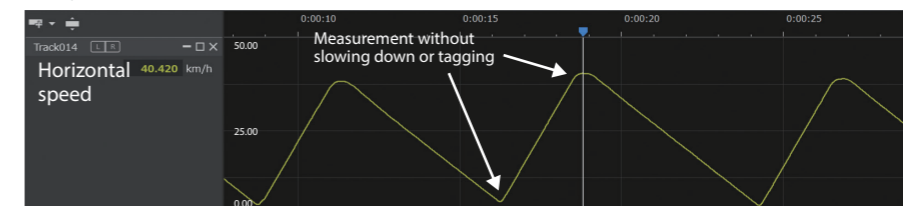

*Turn the accelerator ON and OFF while driving with fixed gears

Features

Easy-to-use design

Compact designed for on-board measurement



Palm size, compact and lightweight body (LC-8300A GPS Speedometer)

Test results are recorded in the built-in storage or USB memory. (Standalone test mode)

Space saving of about 60% by volume compared to the existing models. Further, the IMU is built into the main unit to reduce wiring, and the storage function is equipped with the main unit to test without a PC. It can be used not only for four-wheeled vehicles, but also for vehicles with limited installation space, such as motorcycles, agricultural machineries, and construction machineries.

* When it is difficult to fix the main unit horizontally, the external IMU (optional) connection is useful.

Display for ease of use



LC-0089A Touch panel display

START, STOP, RESET be operated from either the touch panel or remote box.

The display installed in a vehicle has a LCD touch panel which makes it easy to see while driving, and it is a user-friendly UI.

Showing test status lighting yellow during measurement Number of captured satellite

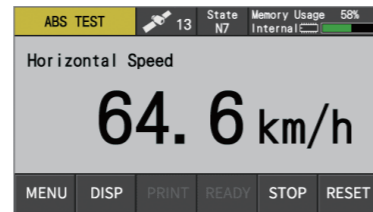

Large, clearly visible display even while driving

JCSS*1 calibration conforming to IATF16949*2

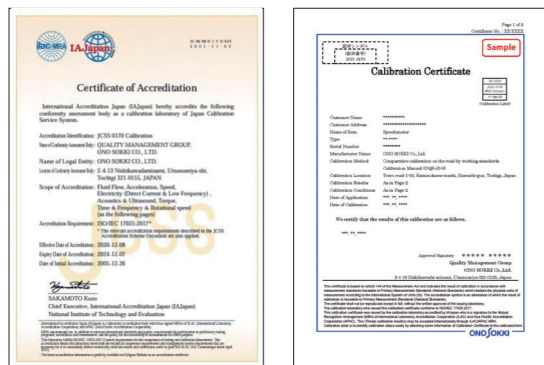

As a JCSS accredited company, we provide calibration services for the GPS Speedometers. The JCSS calibration certificate meets the requirements of IATF16949 Section 7.1.5.3.2*3 and can be used by companies that have already obtained IATF16949 certification.

*1: JCSS stands for Japan Calibration Service System. Ono Sokki can issue the calibration certificates with the JSCC accreditation symbol, which is acceptable in the world through the ilac-MRA.

*2: IATF16949 is an international standard for quality management systems specific to the automotive industry. Many automobile manufacturers around the world have adopted it as a global procurement standard for automobile parts.

*3: In the section 7.1.5.3.2, the instrument calibration certificate shall be calibrated by the laboratory accredited by ISO/IEC 17025 and the certificate shall include the mark of a national accreditation body.

Calibration Procedures and Type of Instruments /Materials to be calibrated		Range	Expanded Uncertainty*4
Speed measuring device	Vehicle speed meter	15 km/h*5	0.05 km/h
		40 km/h	0.04 km/h
		80 km/h*5	0.05 km/h
		120 km/h*5	0.06 km/h

*4 Level of confidence approximately 95 %

*5 Option

System configuration

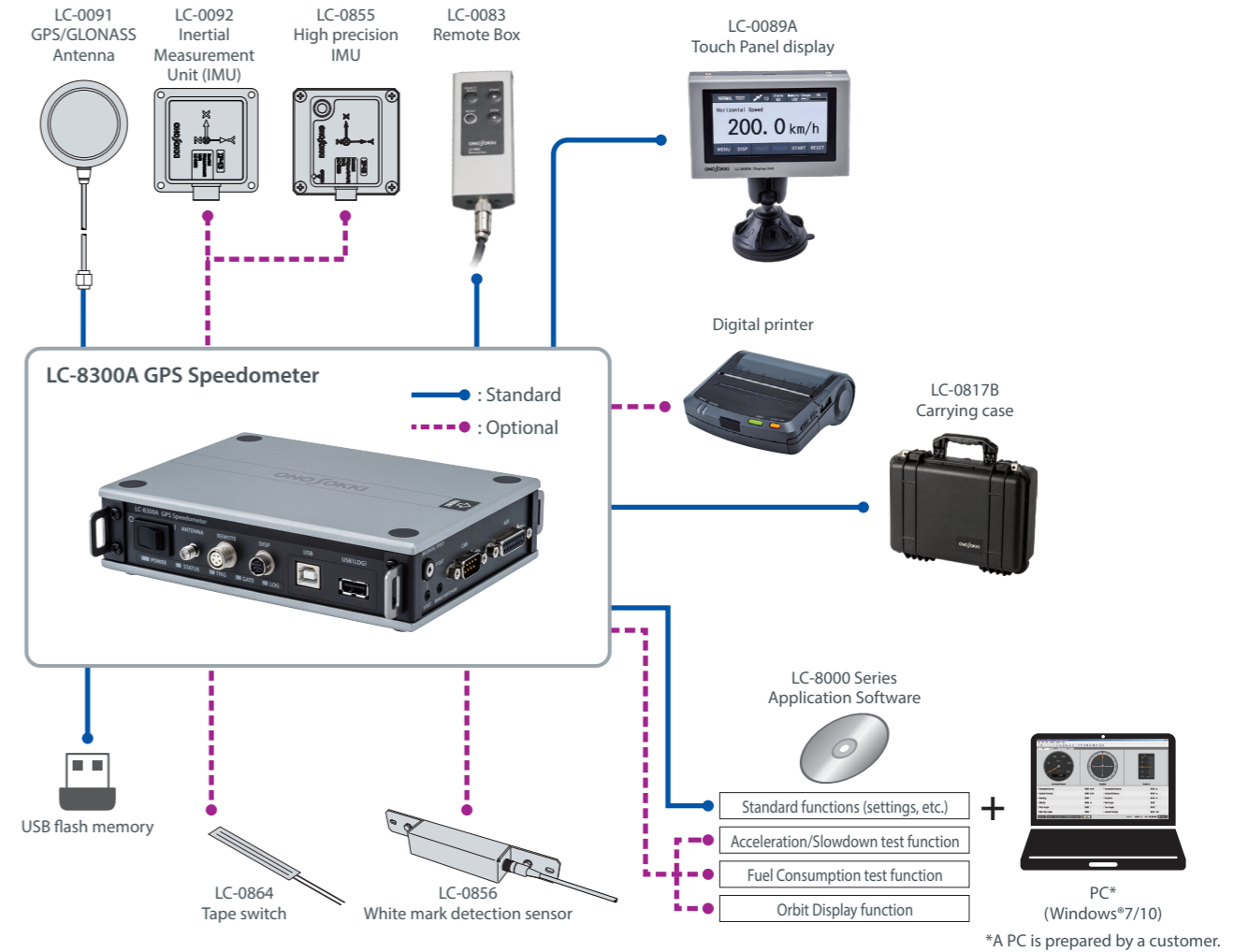

*A PC is prepared by a customer.

Milestones of Our Speedometers

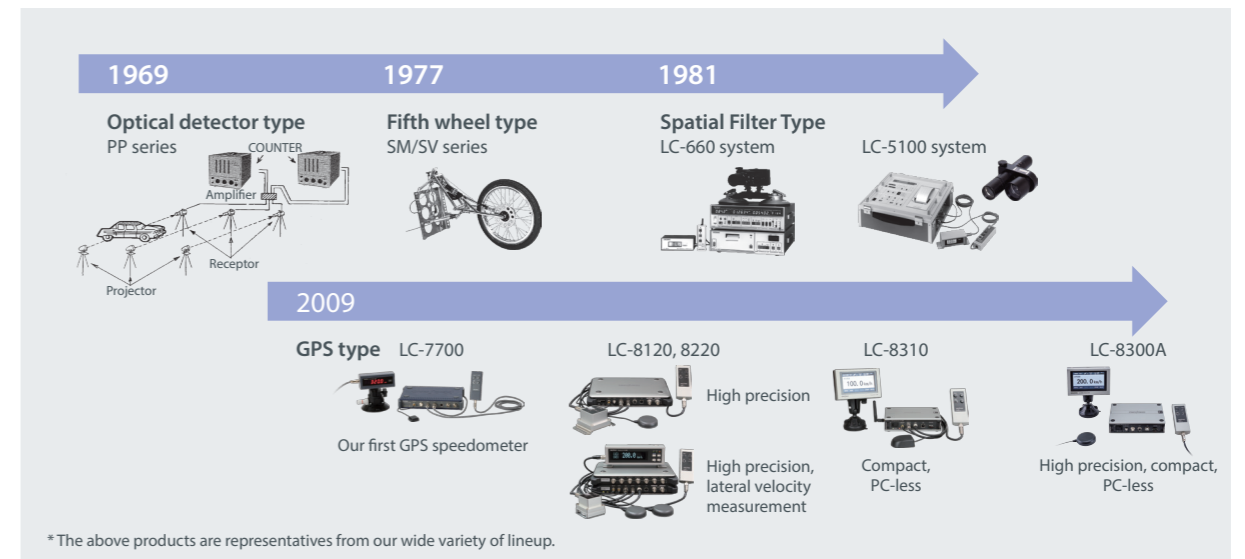

* The above products are representatives from our wide variety of lineup.

Application examples

Driving performance evaluation of electric vehicles

There is a lineup of various measuring instruments that measure the motor rotation speed, acceleration/ deceleration G, etc., which are essential for evaluating the driving performance of electric vehicles. We provide comprehensive applications from detector selection to measurement and analysis of recorded data.



Analysis result image Sudden acceleration (0→90 km/h)

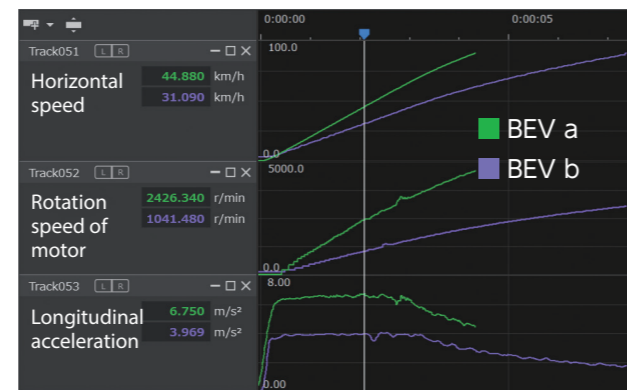

Configuration example

Model	Product name
LC-8300A	GPS Speedometer
LC-0092	Inertial Measurement Unit (IMU)
LC-0836	IMU data Output function
LC-0827	Hardware Acceleration Test function
LC-0831	Acceleration/Deceleration Test function
LC-0866	Auxiliary input/output cable
CT-6700 or HT-6200	Digital Engine Tachometer Handheld Digital Tachometer
OM-1500	Motor/engine RPM detector
OS-5100	O-Solution Platform

Actual vehicle NV test

Actual vehicle NV test is performed using a combination of FFT analyzer and GPS speedometer. Input the digital signals output from the LC-8300A to the DS-5000, apply trigger, and execute synchronized recording. With the various functions of LC-8300A, you can perform tests with good reproducibility.



*1 Outputs voltage according to speed. Units can be changed.
*2 Hi (5 V) during recording, Lo (0 V) otherwise

Analysis result image Sudden acceleration 0 ⇒ 90 km/h Rotational tracking analysis

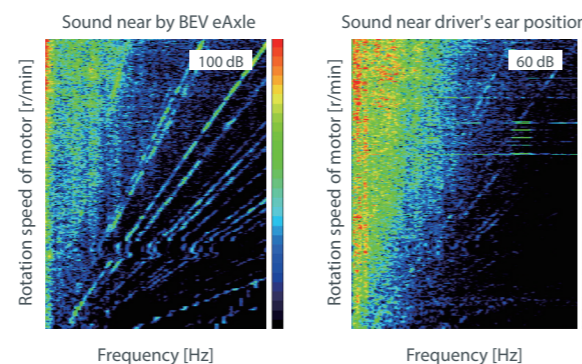

Configuration example

Model	Product name
LC-8300A	GPS Speedometer
LC-0866	Auxiliary input/output cable
DS-5000 series	Data Station (Hardware)
OS-5100	O-Solution Platform
OS-0522	FFT Analysis function
OS-0523	Tracking Analysis function
OS-0512	Hardware Connecting function
NP series	Accelerometer
MI series	Microphone

Deceleration and braking distance in braking test, drift amount measurement

It calculates evaluation indexes for braking tests such as deceleration and braking distance, and measures the amount of drift during vehicle braking.

Major measurement items:

- Mean saturation deceleration (MFDD)
- Maximum deceleration
- Braking distance, Corrected braking distance
- Braking time
- Drifting value (LC-0833 required)

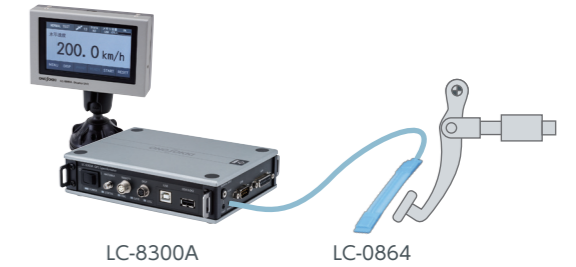

Configuration example

Model	Product name
LC-8300A	GPS Speedometer
LC-0828N	Hardware Brake Test function
LC-0831	Acceleration/Deceleration Test function
LC-0833	Orbit Display Software*
LC-0864	Tape switch

*Necessary when measuring the drifting value

Analysis result image Sudden braking (120→0 km/h)

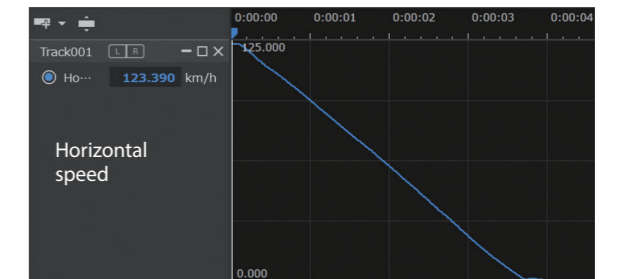

Actual vehicle fuel consumption test

The GPS speedometer and the flow detector are installed in the vehicle to measure the actual vehicle fuel consumption (constant-speed fuel consumption, pattern-mode fuel consumption).

- Flow detector lineup suitable for on-board measurement
- In combination with the GPS speedometer and the fuel consumption test software, the fuel consumption can be measured in actual vehicle/actual driving.

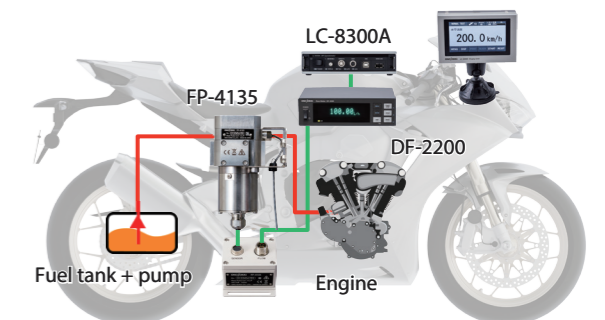

Configuration example

Model	Product name
LC-8300A	GPS Speedometer
LC-0832	Fuel Consumption Test function
DF-2200	On-Board Flow Meter
FP-4135	On-Board Volumetric Flow Detector
FP series	Flow signal/Temperature signal cables

*The fuel consumption test is performed in PC test mode. A PC is required.

Analysis result image Visualized and analyzed by the LC-0832

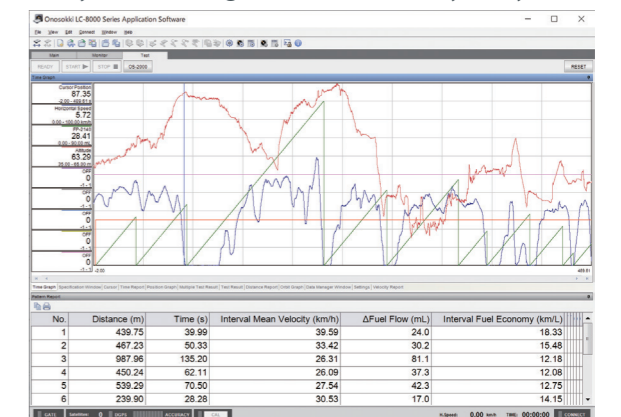

Application software

When connected to the GPS speedometer, the software displays current vehicle and measurement environment conditions (such as vehicle speed, gradient and direction, and satellite acquisition status) as numerical values or graphical meter readouts. In addition to data monitoring and logging, it enables to set and change test conditions for the GPS speedometer. Also, by adding optional software, it is possible to perform vehicle tests that comply with regulations such as acceleration/deceleration, coasting, and fuel consumption.

LC-0831 Acceleration/Deceleration test
LC-0832 Fuel consumption test

"Meter" display as a window

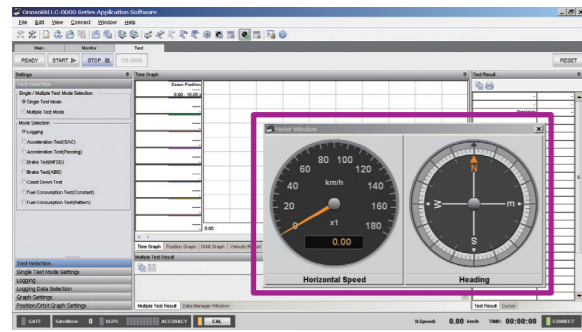

Meter display can be set as a separate-frame window. Displaying meter items are selectable to make various layout.

Language Selection

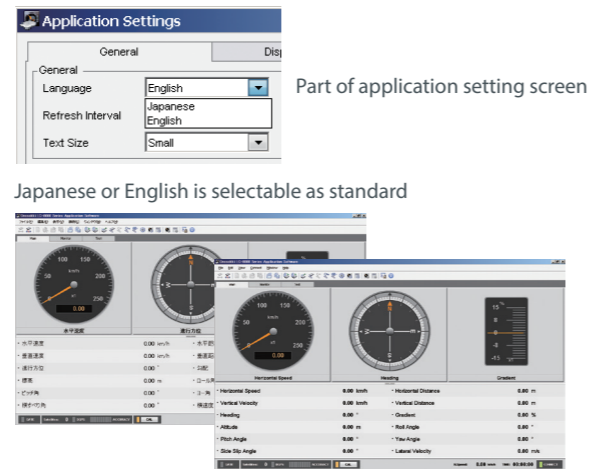

Part of application setting screen

Japanese or English is selectable as standard

"Docking Window" enables various layout building

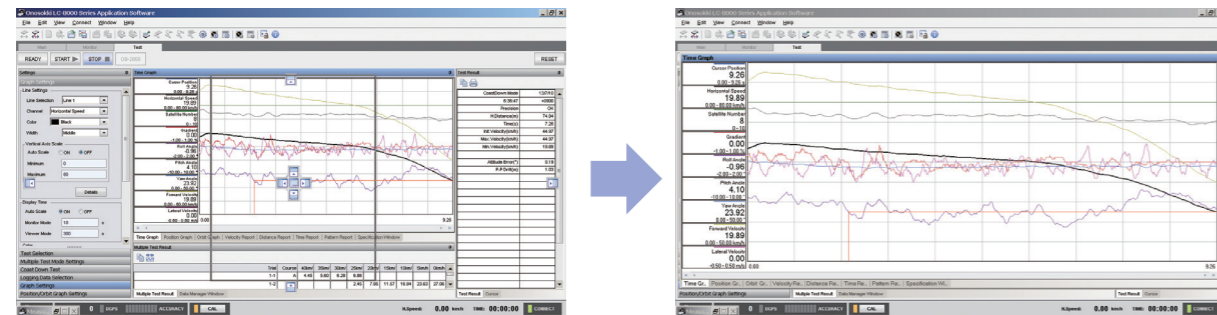

<Test screen>

The dockable locations are displayed by dragging the central window. Screen layout can be changed according to the measurement scene.

<Test screen/ example of layout>

Example of a graph display in large image by setting to hide items other than the central graph window. It can also display only a single window without using docking.

Multiple test function

LC-0831 Acceleration/Deceleration test
LC-0832 Fuel consumption test

- The multiple test results are collectively managed in the Data Manager window.
- This function allows easily to verify the difference of each test result.

*One item of data is created with the Ready → Start → Stop measurement sequence.

Val	Rema	Tri	Dir	Preci	Direction	H.Distanc	Time(s)	Init.Veloci	Max.Velo	Min.Veloci	MFDD	Corrected I	Correc	Vb(km	Ve(km/	St(km)	Se(m)	P-P D	Attitu	V-T(m	D.T	V.DX
Val	1	13	OK		23.81	12.86	3.42	29.86	29.86	0.00	2.705	20.0	5.8	23.86	2.94	4.70	12.70	0.29	0.40	2.42	2.20	2.68
Val	2	13	OK		-154.53	16.37	3.73	29.97	29.97	0.00	2.454	20.0	7.3	23.94	2.99	7.35	16.21	0.04	-0.25	2.23	2.35	2.12
Val	3	13	OK		24.56	22.72	4.94	30.00	30.00	0.00	1.953	20.0	10.1	23.97	2.98	11.37	22.54	0.55	-0.05	1.69	1.86	1.53
Val	4	13	OK		-155.33	14.33	3.38	29.91	29.91	0.00	2.683	20.0	6.4	23.90	2.92	6.11	14.20	0.11	0.25	2.46	2.51	2.41
Val	5	13	OK		24.81	10.29	2.56	29.74	29.74	0.00	3.326	20.0	4.7	23.73	2.95	3.76	10.19	0.22	0.16	3.22	3.14	3.32
Val	6	13	OK		-156.70	10.58	2.59	29.90	29.90	0.00	3.288	20.0	4.7	23.83	2.89	3.92	10.48	0.11	0.33	3.21	3.15	3.26

Orientation detection function

- Function available for multiple test.
- Used when reciprocal running tests are required.
- By setting the driving direction of the vehicle, measurement data is respectively recorded to course A and course B.
- Useful for rearranging result, and displaying average value for each course.

<Results of multiple test>

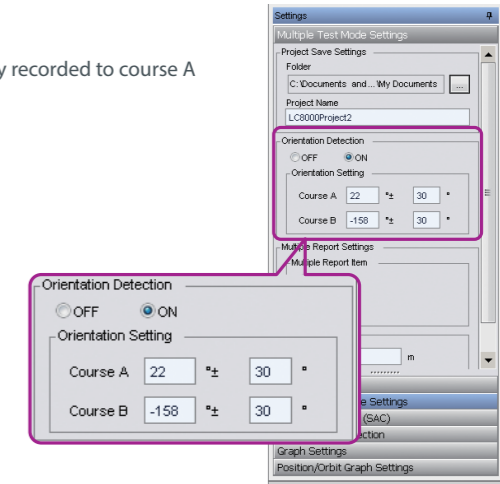

Divided coasting test function

- Function available for coasting test.
- Test is started and finished automatically by setting the number of divisions and the test start speed.
- Multiple recorded data are merged to see in one table.

<Results of multiple test before merging>

<Results of multiple test after merging>

LC-0831 Acceleration/Deceleration test

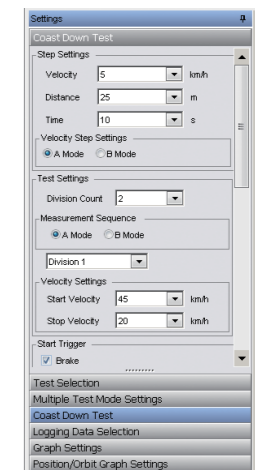

<Divided coasting test setting>

Traveling trace/traveling direction

LC-0833 Orbit display

- The traveling trace and the traveling direction* can be displayed.
- *The LC-8220, GPS Vector Speedometer is required as the LC-8300A cannot display the traveling direction correctly.

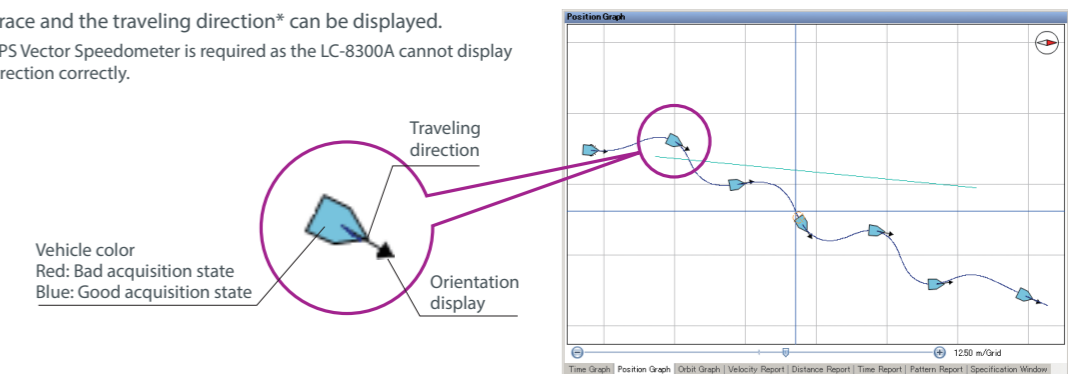

Vehicle testing functions

A wide variety of test functions are available to support various vehicle tests. You can display and save the results calculated by the formula regulated by the law. In addition to time-series data, it can be saved in report format.

Functions	Options		
	Standalone Test Mode	PC Test Mode	
Basic Test	Standard	Standard	
Periodic Measuring Test			
Acceleration Test	Standing Start Acceleration	LC-0827	
	Passing Acceleration		
Brake Test	MFDD	LC-0831	
	ABS		
	Wet grip		
	Fade		
Coasting Test	Made to order	-	
Fuel Consumption test	LC-0829	LC-0831	
	Constant-speed fuel consumption	-	LC-0832
Orbit Analysis	Pattern-mode fuel consumption	-	LC-0833

Basic Test Mode (Standard)

Measures the velocity, distance and elapsed time from the start to the end of measurement.

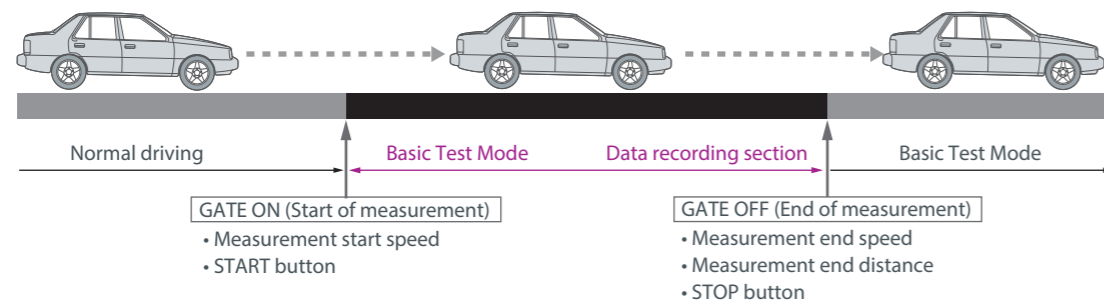

Periodic Measuring Test

Measures the following items from the start (GATE ON) to the end (GATE OFF) of measurement: maximum horizontal velocity, minimum horizontal velocity, average horizontal velocity, horizontal distance traveled, elapsed time, etc.

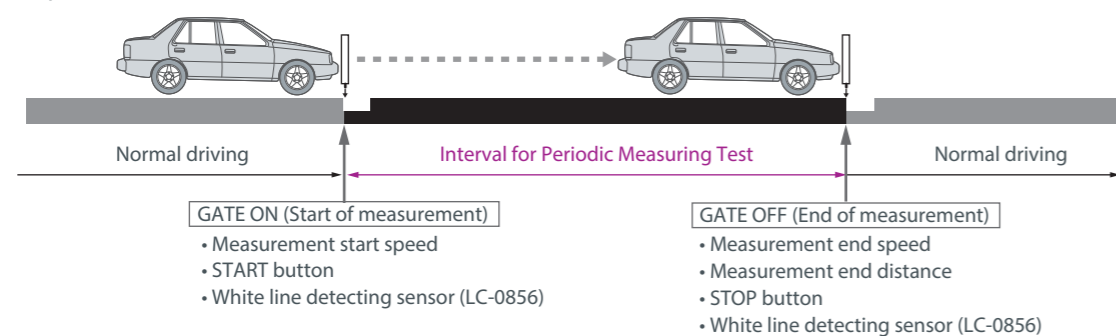

Acceleration Test

Required options Standalone Test Mode LC-0827 Hardware Acceleration Test function
PC Test Mode LC-0831 Acceleration/Deceleration Test function

Standing Start Acceleration

Measures the velocity, the distance traveled, the elapsed time and the sectional acceleration at every specified step from starting measurement (zero km/h) until the vehicle reaches the speed of 100 km/h*1 or the distance of 400/1000 m*2.

*1 Speed can be set arbitrarily.
*2 Distance can be set arbitrarily.

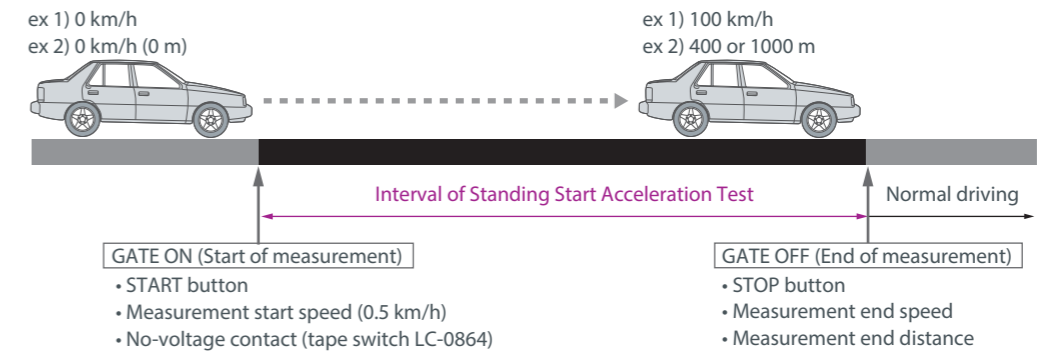

Passing Acceleration Test

While accelerating from a normal driving state, start testing at the point where the vehicle reaches the specified velocity or crosses the white line, and continue to accelerate. Measures the time it takes for the vehicle to reach a specified velocity or distance.

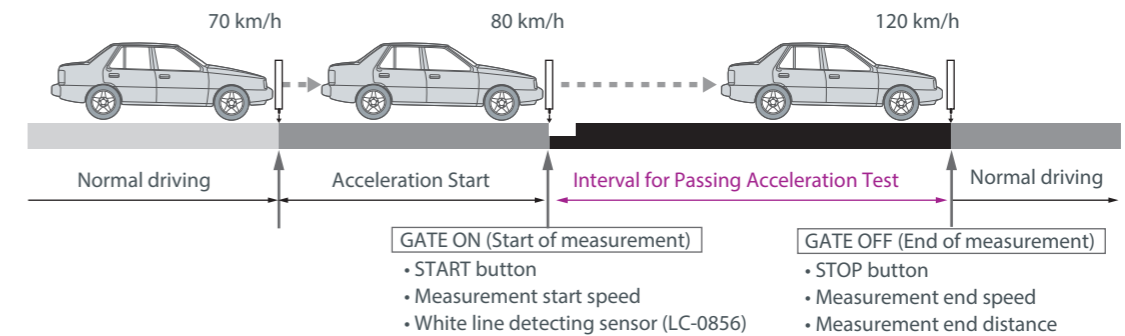

Brake Test

Required options Standalone Test Mode LC-0828N Hardware Acceleration Test function
PC Test Mode LC-0831 Acceleration/Deceleration Test function

MFDD

A brake test mode applicable to the brake efficiency evaluation standard, MFDD (mean fully developed deceleration). Measure braking distance, braking time, MFDD, etc. from the start of application of the brake until the vehicle stops.

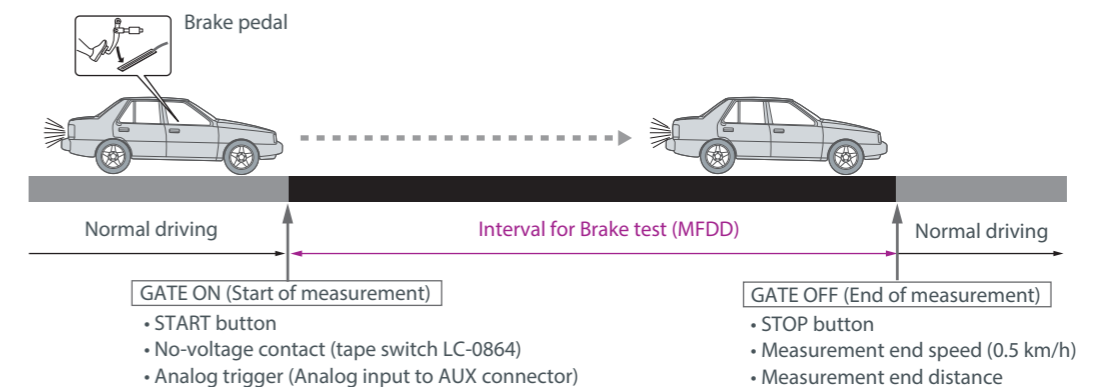

Vehicle testing functions

Brake Test

Required options Standalone Test Mode LC-0828N Hardware Acceleration Test function
PC Test Mode LC-0831 Acceleration/Deceleration Test function

ABS/Wet grip

Measures the velocity/ travel distance (braking distance)/elapsed time (braking time)/sectional deceleration at each specified step from the start of application of the brake until the vehicle stops. ABS calculates maximum deceleration (Z), wet grip calculates average deceleration (AD).

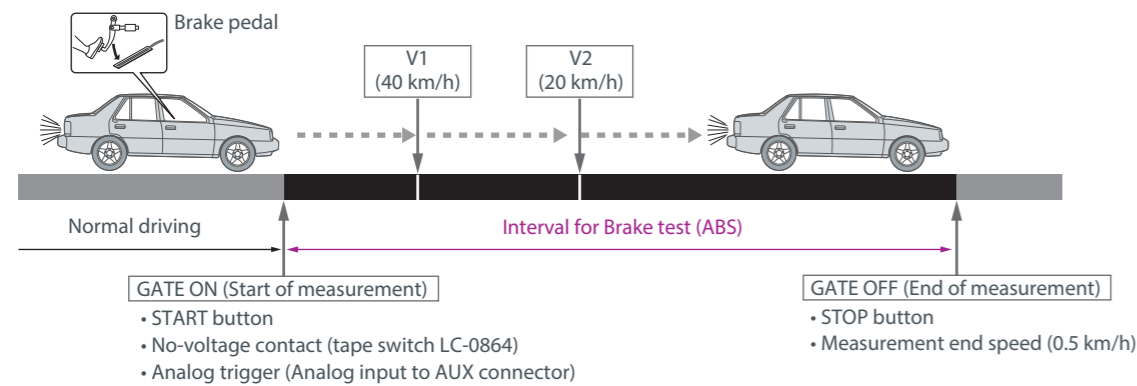

Fade Recovery Test (Made to order)

Evaluates the brake performance at high temperature by repeating Brake test. A MFDD (mean fully developed deceleration) is calculated for each deceleration from brake start speed v_1 to brake end speed v_2 . The measurement is eventually terminated when the vehicle reaches the measurement end speed by decelerating from the measurement start speed. The braking distance and MFDD are calculated.

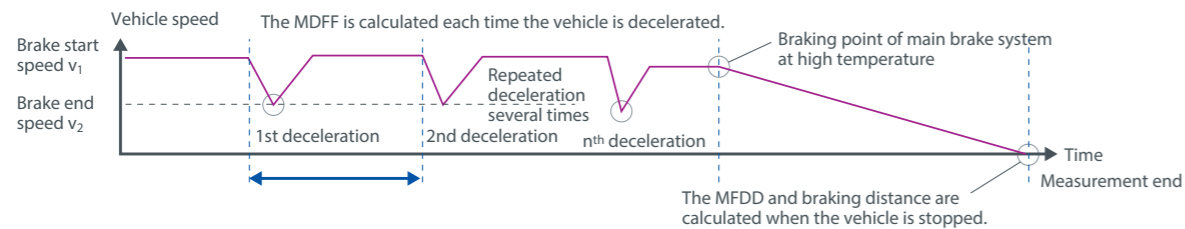

Coasting test

Required options Standalone Test Mode LC-0829 Hardware Acceleration Test function
PC Test Mode LC-0831 Acceleration/Deceleration Test function

Measures coasting ability of vehicles, such as coefficient (C/D factor), sectional average velocity and distance traveled and elapsed time from when the accelerator pedal is released (or neutral is selected) and the speed drops below the speed at the start of measurement (or the START button is pressed) to when the speed reaches the end of the measurement (or when the STOP button is pressed).

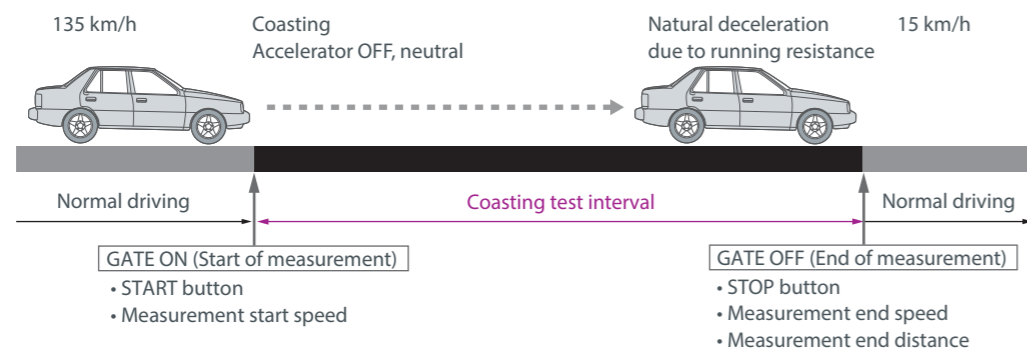

Fuel consumption test

Required option PC Test Mode LC-0832 Fuel Consumption Test function

Constant-Speed Fuel Consumption Test

Measures the fuel economy of a vehicle traveling at a constant speed with constant accelerator application on a horizontal, straight-line road. The test can acquire data such as travel distance, elapsed time, mean speed, cumulative fuel consumption and cumulative fuel economy. Measurement result data is acquired for each distance step or time step after the start of measurement.

Pattern-Mode Fuel Consumption Test

Measures values for each of multiple intervals for a varied travel pattern: distance, time, interval mean velocity, interval fuel flow rate, interval fuel economy, mean velocity, fuel flow rate and fuel economy. For example, executing a pattern-mode fuel consumption test with one circuit of the proving ground set as one interval enables to acquire fuel economy and other measurement results for individual circuits or the totals for all the circuits.

Fuel consumption test system configuration example

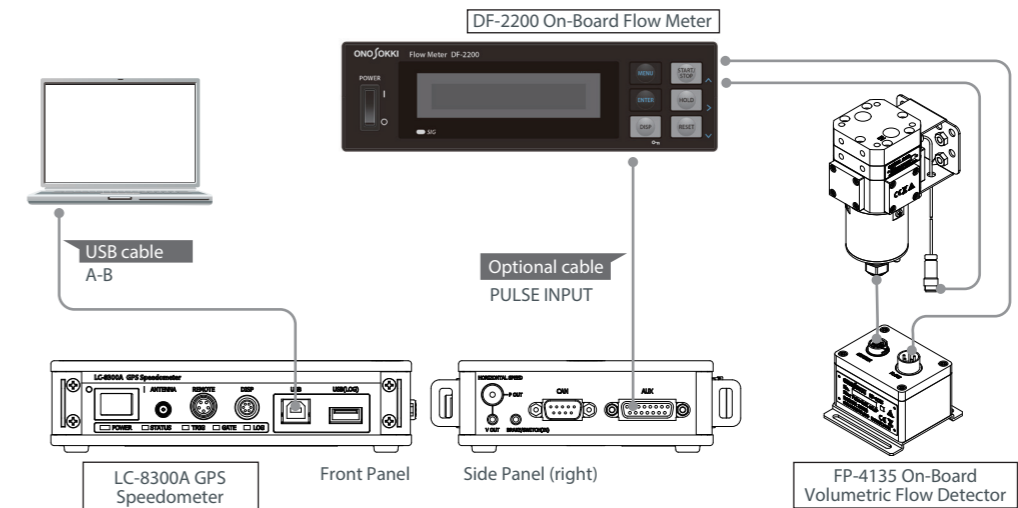

Orbit analysis

Required option PC Test Mode LC-0833 Orbit Display function

Traveling Trace Measurement

Measures the vehicle's traveling trace between the start and end of measurement, and graphs the measured results as a relative traveling trace.

*The LC-8220 GPS vector speedometer is required to display vehicle heading.

Drift measurement

Measures the drift amount between the start and end of measurement.

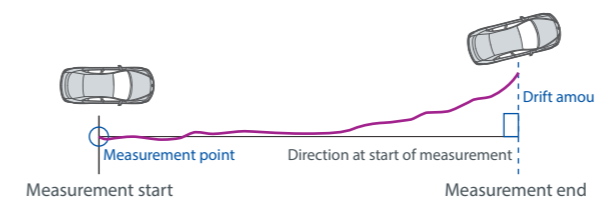

Minimum Rotation Radius Measurement

Measures the minimum rotation radius of a vehicle.

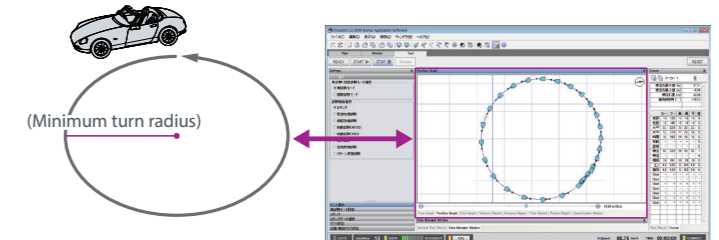

Options

Test mode options

LC-0827*1	Hardware Acceleration Test function	[Standalone Test Mode] Standing Start Acceleration Test, Passing Acceleration Test
LC-0828N*1	Hardware Brake Test function	[Standalone Test Mode] Brake Test (MFDD), Brake Test (ABS)
LC-0829*1	Hardware Coastdown Test function	[Standalone Test Mode] Coasting Test
LC-0831	Acceleration/Deceleration Test function	[PC Test Mode] Acceleration/Deceleration test
LC-0832	Fuel Consumption Test function	[PC Test Mode] Fuel Consumption test
LC-0833	Orbit Display function	[PC Test Mode] Creating trajectory graphs, calculating drifting value

Optional functions for LC-8300A main unit

LC-0824*1	km/mile select function	Selectable between km system and mile system 1 mile = 1.609344 km (distance and speed) 1 L = 0.264172053 gallon (related to fuel)
LC-0826*1	Vertical Direction Measurement function	Measurement of vertical velocity, vertical distance, and slope.
LC-0836*1	IMU Data Output function	Measurement of X, Y and Z accelerations, X, Y and Z angular velocities, roll, pitch and yaw angles
LC-0854*1	CAN Output function	Can be used to output CAN data.

Sensors, cables, peripherals

LC-0091	GPS/GLONASS Antenna	Cable length 5 m
LC-0092*2	Inertial Measurement Unit (IMU)	External Inertial Measurement Unit (IMU) with 5 m cable
LC-0855*2	High precision IMU	Horizontal distance accuracy: ±0.05%, with 5 m cable
LC-0856	White mark detection sensor	Set the timing at which a vehicle reaches a dedicated white mark as a trigger for starting or terminating measurement
LC-0864	Tape switch	Affix it to the brake/accelerator pedal, set the timing at which you step on the pedal as a trigger.
LC-0082	Power supply clip for battery	Red, black clip, cable length 5 m, fuse 3A
-	AC adapter for LC-8300A main unit (PS-P20023E)	AC 100 to 240 V, power cable sold separately
LC-0860	CAN cable	For CAN communication, 2 m (without terminator)
LC-0861	CAN terminal register adapter	
LC-0866	Auxiliary input/output cable	AUX connector cable (analog input:4 channels, pulse input: 1 channel, digital output) *Can not be used with auxiliary input/output cable for white mark detection sensor connection
-	Auxiliary input/output cable for white mark detection sensor connection	*Can not be used with LC-0866.
-	Mobile printer (DPU-S445-00C-E)	Serial printer
-	Serial communication cable for printer (PS-D11125A1.5M)	For connecting LC-8300A and digital printer, cable length 1.5 m
-	AC adapter for printer (PW-D0940-W2)	AC 100 to 240 V
-	AC adapter cable for printer (CB-JP04-18A-E)	For Japan use
-	Battery pack for printer (BP-L0725-B1)	Li-ion battery charger
-	Thermal paper for printer (TP-341L-1)	10 rolls (28 m/roll)

*1: The addition of optional functions after delivery needs to be done at our factory.
*2: The installation of options after delivery needs to be done at our factory.

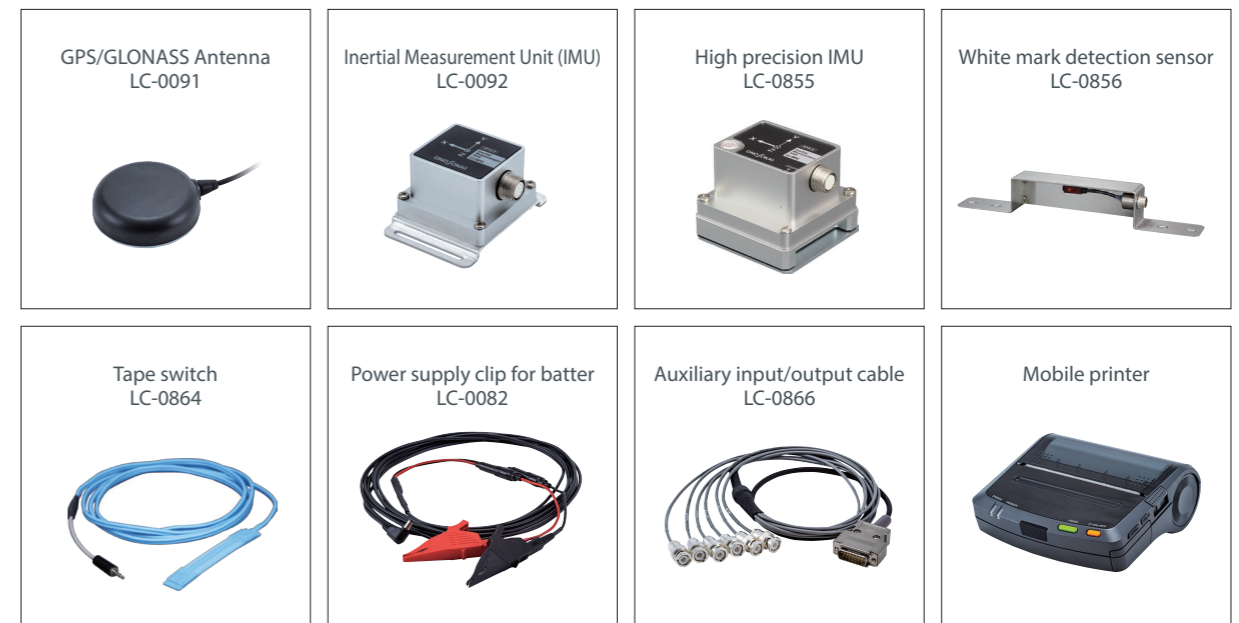

Connecting optional devices

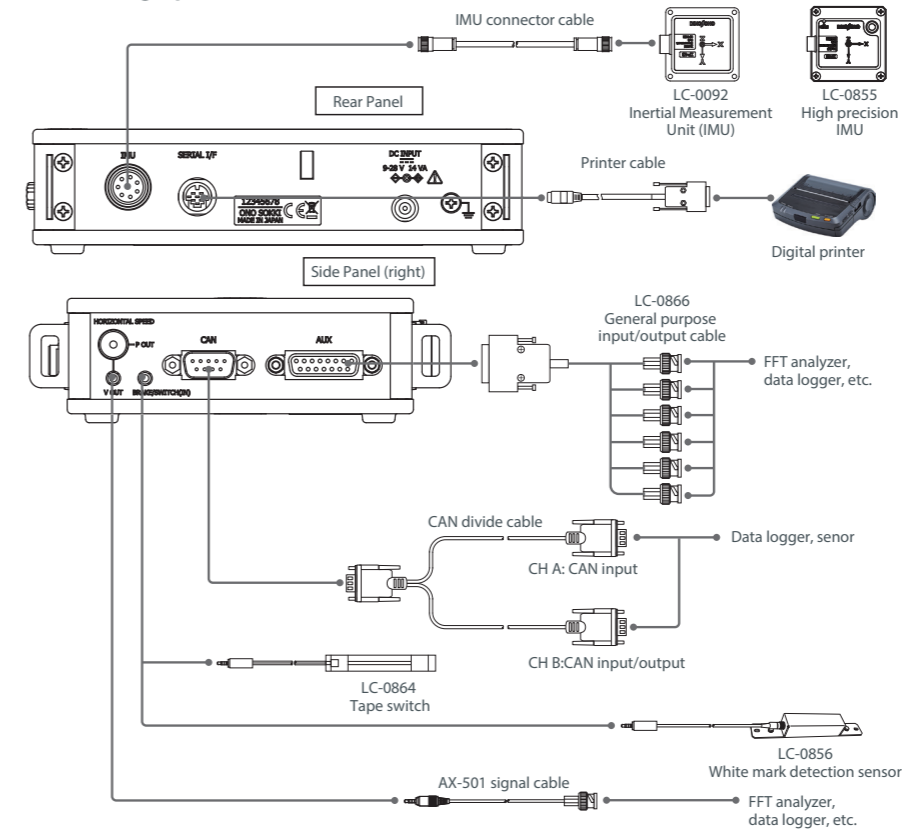

Connecting White Mark Detection Sensor

You can set the timing at which a vehicle reaches the white mark as a trigger for starting or terminating measurement.

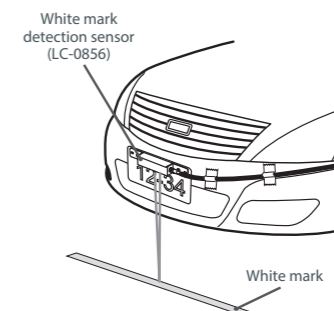

Specifications

LC-8300A High-sensitive GPS Speedometer

Measurement accuracy	Horizontal speed	Measurement range/ accuracy	0.1 to 500.0 km/h/within ±0.1 km/h (Horizontal speed 30 km/h or more, when 7 or more of satellites acquisition, no influence of multipath)
	Horizontal distance	Accuracy	±0.1% (when using built-in IMU, external IMU) (forward distance 300 m, horizontal speed 30 km/h or more, when 7 or more of satellite acquisition, no influence of multipath) ±0.05% (when using the High-Sensitive IMU) (forward distance 300 m, horizontal speed 30 km/h or more, when 7 or more of satellite acquisition, no influence of multipath)
Standard measurement items	Horizontal speed (km/h), horizontal distance (m), time (s), UTC time, number of satellite capture, HDOP(Horizontal Dilution of Precision), heading (°), North speed (km/h), East speed (km/h), North distance (m), East distance (m), travelling distance (m), latitude (dms), longitude (dms), altitude (m)		
Optional measurement items	Lateral distance (m), vertical speed (km/h), vertical distance (m), VDOP (Vertical Dilution of Precision), lateral sideslip amount (m), travelling distance (m), roll angle (°), pitch angle (°), yaw angle (°), X acceleration (m/s ²), Y acceleration (m/s ²), Z acceleration (m/s ²), X angular speed (°/s), Y angular speed (°/s), Z angular speed (°/s), gradient (%)		
Update (output)frequency	100 Hz		
General specifications	Power requirement	DC 9 to 28 V (non-isolation), AC 100 to 240 V (AC adapter used : option) / 14 VA max(DC power input, when connected peripheral devices)	
	Operating/storage temperature	Main unit	0 to 50 °C / -10 to 60 °C (Humidity 20 to 80 %RH, with no condensation)
		Antenna	-40 to +85 °C / -40 to +85 °C (Humidity: 45 to 95 %RH with no condensation)
	Protection class	Antenna	IP67
	Vibration resistance	27.1 m/s ² (rms value, random vibrations, 1 hour in each of the XYZ directions)	
Impact resistance	500 m/s ² (reaction time 11 ms)		
Outer dimensions/weight	Main unit	Approx. 170 x 120 x 40 mm (not including protruded section) / Approx. 750 g	
	Display unit	Approx. 132 x 86 x 33 mm (not including protruded section) / Approx. 450 g	
	Remote box	Approx. 115 x 45 x 20 mm (not including protruded section) / Approx. 80 g	
	Antenna	Ø 57 x 15 mm (Antenna) / Approx. 110 g (excluding the cable)	
Output	Speed analog output	Range	0 to 10 V SI Units : 0 to 10 V/0 to 500.0 km/h, mile units : 0 to 10 V/0 to 250.0 mile/h
		Load resistance	10 kΩ or more
	Distance pulse output	Resolution	SI Units : 10, 5, 1 mm/pulse mile Units : Selectable from 16.0934, 8.0467, 1.6093 mm/pulse
		Output delay time	10 ms or less
		Output signal	Square wave pulse output Hi 5 V ± 0.5 V, Lo 0.5 V or less
		Duty	50 % ± 10 %
Load resistance	Load 1 kΩ or more		
Digital output	Selectable from Gate output/Velocity determination output		
Input	Voltage input*1	Number of channels	4
		Resolution	16 bit
		Range	±20 V
		Sampling frequency	100 Hz
		Analog trigger function	The function to set measurement start- stop trigger by voltage value CH1 : measurement start trigger, CH1 : measurement start trigger
	Pulse input*1	Number of channels	1
		Input coupling	AC or DC
		Function	Pulse count/frequency/duty
		Input waveform	AC selected : sine wave, DC selected : square wave
	External Trigger Input	Selectable from no-voltage contact/voltage contact	
CAN	Common specification	Baud rate	125 k, 250 k, 500 k, 1000 k bps
		Protocol	Conforms to CAN Ver2.0B
	Input	Input port	2 (port A, port B)
		Number of data acquisition	32ch/1 port (64ch max.)
		Others	CAN input should be selected at port B side.
	Output*2	Output update frequency	Selectable from OFF/1 Hz/2 Hz/5 Hz/10 Hz/20 Hz/100 Hz
		Output item (standard)	Horizontal speed (km/h), speed unit, horizontal distance, (m), UTC time, number of satellite acquisition, trigger of start/stop/reset, GATE status, internal condition, accuracy condition, HDOP (Horizontal Dilution of Precision), heading (°), latitude (dms), longitude (dms), altitude (m)
		Output item (option)	Vertical velocity (km/h), vertical distance, (m), VDOP (Vertical Dilution of Precision), drift amount (m), roll angle (°), pitch angle (°), yaw angle (°), X acceleration (m/s ²), Y acceleration (m/s ²), Z acceleration (m/s ²), X angular speed (°/s), Y angular speed (°/s), Z angular speed (°/s), gradient (%)
		Others	CAN input function at B port side is not available when the output function is enable.
	Remarks	Input from CAN connector side.	
Other functions	Buzzer, external trigger input, DC12 V output for general-purpose sensor, condition memory, print by optional printer, storage function		
Test functions	Basic test functions of hardware	Basic measurement, periodic measuring test	
	Optional test functions of hardware	Starting acceleration test, passing acceleration test, brake test (MFDD), brake test (ABS), fade recovery test, coasting test	
	Basic function of the PC application*3	Basic function (setting of hardware, display of PC measurement result, and so on.)	
	Optional functions of the PC application*3	Acceleration/deceleration test software, Fuel consumption test software, Orbit display software	
Accessories	Touch panel display unit (3.0 m cable attached), GPS/GLONASS antenna, Power cable for cigarette light socket (3.0 m), Pin jack ⇄ BNC cable (2.0 m)x2, USB cable for PC connection (2.0 m), CAN branch cable (0.3 m), USB memory, Installation CD, Instruction manual, Carrying case, Mount adapter for display unit, Base plate for mount adapter		

*1: Input from the side AUX connector with an optional cable

*2: Option

*3: Refer to PC operating environment

LC-0092 Internal Measurement Unit (IMU) (Optional)

X/Y/Z acceleration	Measurement range	-98.0 to 98.0 m/s ²
	Linearity	±0.2% / FS (Reference accuracy)
X/Y/Z angular velocity	Measurement range	-150.0 to 150.0°/s
	Linearity	±0.1% / FS (Reference accuracy)
Operating temperature range	0 to +50 °C (Humidity: 20 to 95 %RH with no condensation)	
Storage temperature range	-10 to +60 °C (Humidity: 20 to 95 %RH with no condensation)	
Cable length	Approx. 5 m	
Degree of protection	IP43	
Outer dimensions	Approx. 56 x 56 x 35 mm (not including protruded section)	
Weight	Approx. 110 g	

LC-0855 High-Sensitive IMU (Optional)

X/Y/Z acceleration	Measurement range	-49.0 to 49.0 m/s ²
	Linearity	±0.1% / FS (Reference accuracy)
X/Y/Z angular velocity	Measurement range	-150.0 to 150.0°/s
	Linearity	±0.03% / FS (Reference accuracy)
Operating temperature range	0 to +50 °C (Humidity: 20 to 95 %RH with no condensation)	
Storage temperature range	-10 to +60 °C (Humidity: 20 to 95 %RH with no condensation)	
Cable length	Approx. 5 m	
Degree of protection	IP43	
Outer dimensions	Approx. 70 x 70 x 43 mm (not including protruded section) Approx. 72 x 72 x 56 mm (when a magnet is attached)	
Weight	Approx. 200 g Approx. 400 g (when a magnet is attached)	

LC-0856 White Mark Detection Sensor

Power supply voltage	12 to 24 VDC
Current consumption	30 mA or less
Light source	Red semiconductor laser (wave length: 655 nm)
Emitted light output	0.5 mW or less
Detection distance	0.2 to 1.5 m
Laser spot diameter	Approx. 6 x 4 mm (at distance of 1 m or less)
Cable length	Approx. 5 m
Reflective sheet	Use supplied reflective sheet (1 m x 2)
Operating temperature range	0 to +50 °C
Degree of protection	IPX3
Outer dimensions	Approx. 300 x 40 x 45 mm
Weight	Approx. 350 g (not including cable)

PC operating environment

OS	Windows*10 / 7 [32/64 bit]*1 Please refer to the software operating environment [Windows] for the details of the version.
Memory	512 MB or more
HDD	80 GB or more
CPU	Intel Core™2 Duo / 2 GHz or more*2
Display	XGA (1024 x 768) or more
USB	USB2.0 (high speed) 1 port or more
Optical drive	Optical drive which can read DVD-R and CD-R is necessary for installation and updating.
Others	Installation of .NET Framework 3.5 is required.*3

1: Windows 10, Windows* 7 are registered trademarks of Microsoft Corporation in the United States and other countries.

*2: Intel, Intel logo, Intel Core, Core Inside are trademarks of Intel Corporation in the United States and other countries.

3: For Windows 10, you need to connect to a network and install it.

Outer dimensions (Unit : mm)

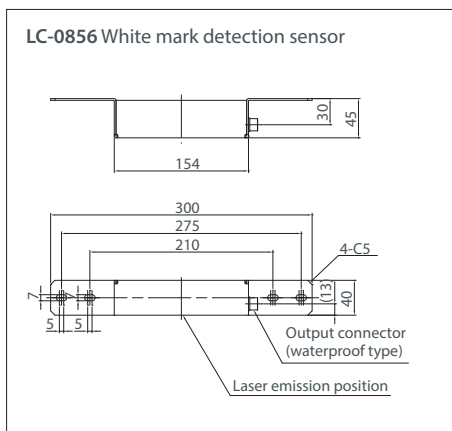
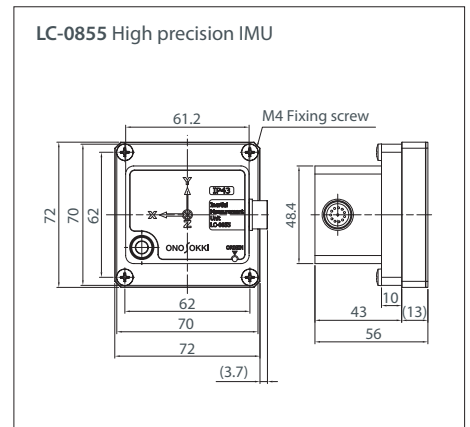
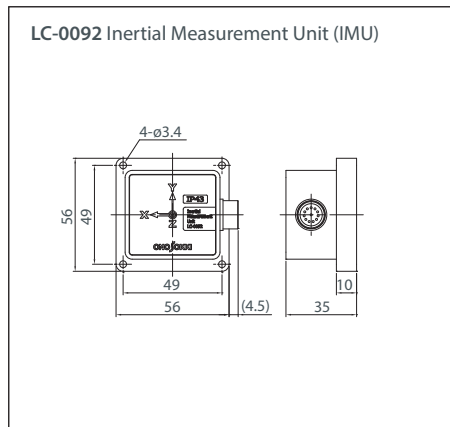
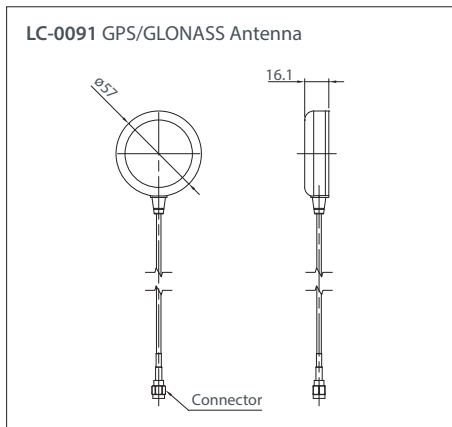
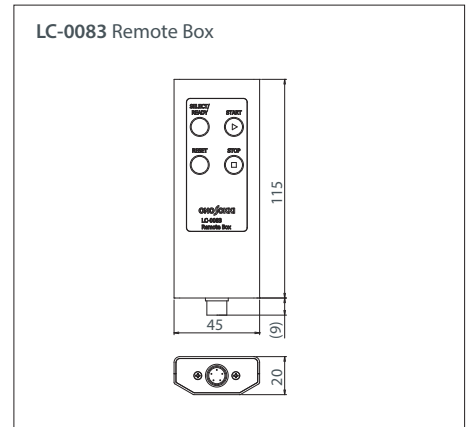
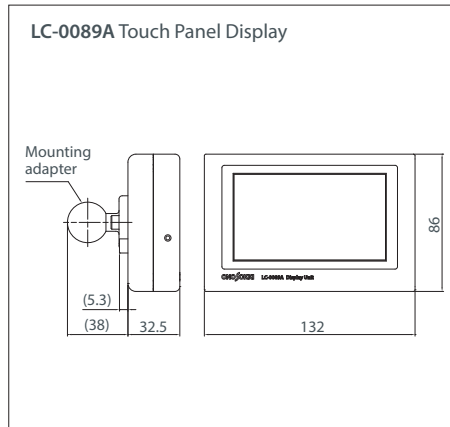
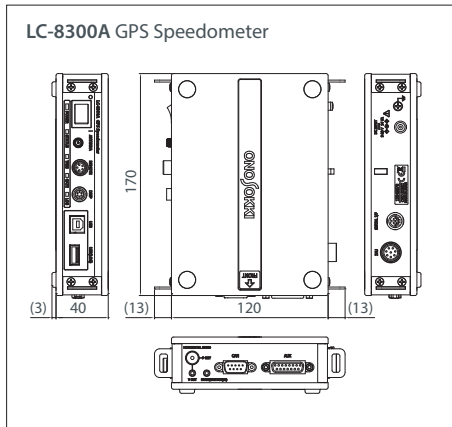

WORLDWIDE ONO SOKKI CO., LTD.

3-9-3 Shin-Yokohama, Kohoku-ku, Yokohama, 222-8507, Japan
 Phone : +81-45-476-9725 Fax : +81-45-476-9726
 E-mail : overseas@onosokki.co.jp

* Outer appearance and specifications are subject to change without prior notice.
 URL: <https://www.onosokki.co.jp/English/english.htm>

U.S.A.
 Ono Sokki Technology Inc.
 2171 Executive Drive, Suite 400,
 Addison, IL. 60101, U.S.A.
 Phone : +1-630-627-9700
 Fax : +1-630-627-0004
 E-mail : info@onosokki.net
<https://www.onosokki.net>

THAILAND
 Ono Sokki (Thailand) Co., Ltd.
 1/293-4 Moo.9 T.Bangphud
 A.Pakkred,
 Nonthaburi 11120, Thailand
 Phone : +66-2-584-6735
 Fax : +66-2-584-6740
 E-mail : sales@onosokki.co.th

INDIA
 Ono Sokki India Private Ltd.
 Plot No.20, Ground Floor, Sector-3,
 IMT Manesar Gurgaon-122050,
 Haryana, INDIA
 Phone : +91-124-421-1807
 Fax : +91-124-421-1809
 E-mail : osid@onosokki.co.in

P.R.CHINA
 Ono Sokki Shanghai Technology Co., Ltd.
 Room 506, No.47 Zhengyi Road, Yangpu
 District, Shanghai, 200433, P.R.C.
 Phone : +86-21-6503-2656
 Fax : +86-21-6506-0327
 E-mail : admin@shonosokki.com