

Key-groove dimension on both shaft ends

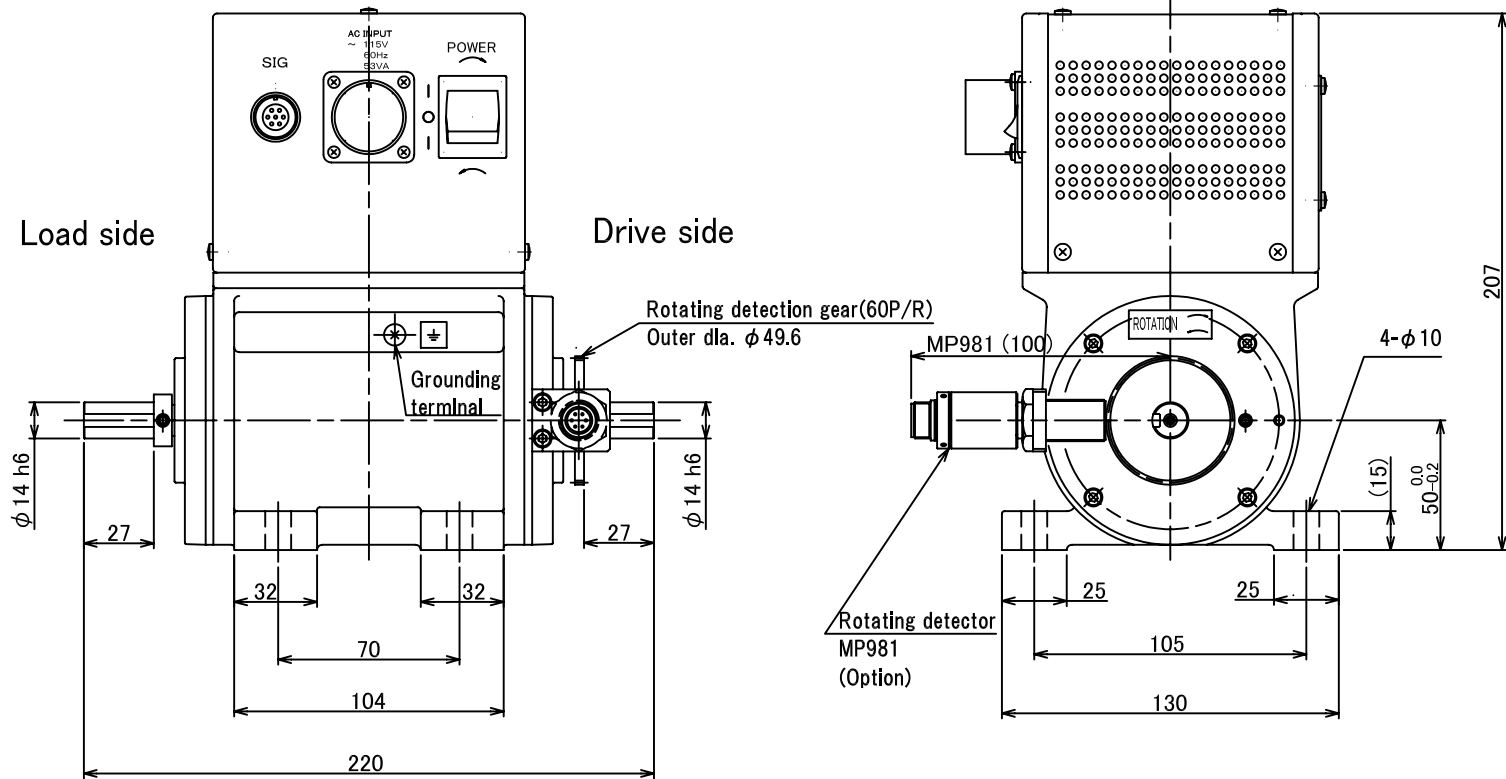

(Note)

1. Same dimension for 115V AC and 230V AC specification.

SS-100E/SS-200E

ONOSOKKI