

Cover removed

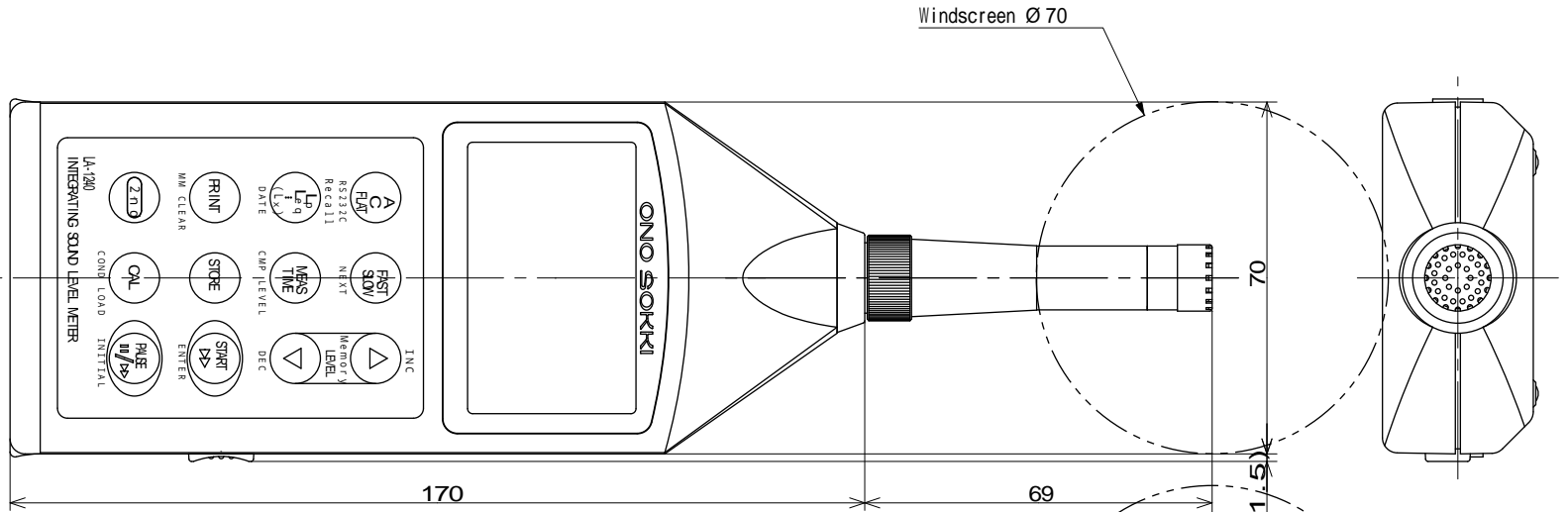

Windscreen Ø 70

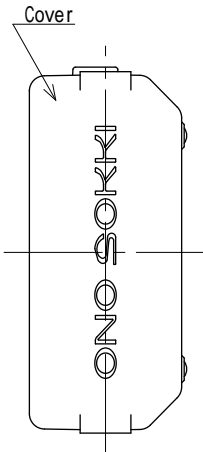
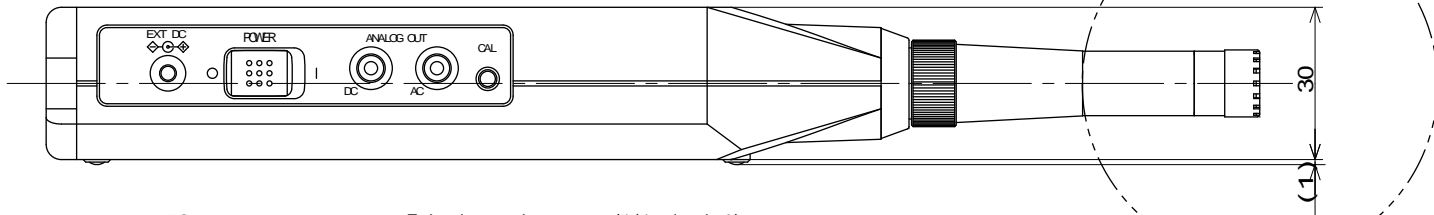

Cover

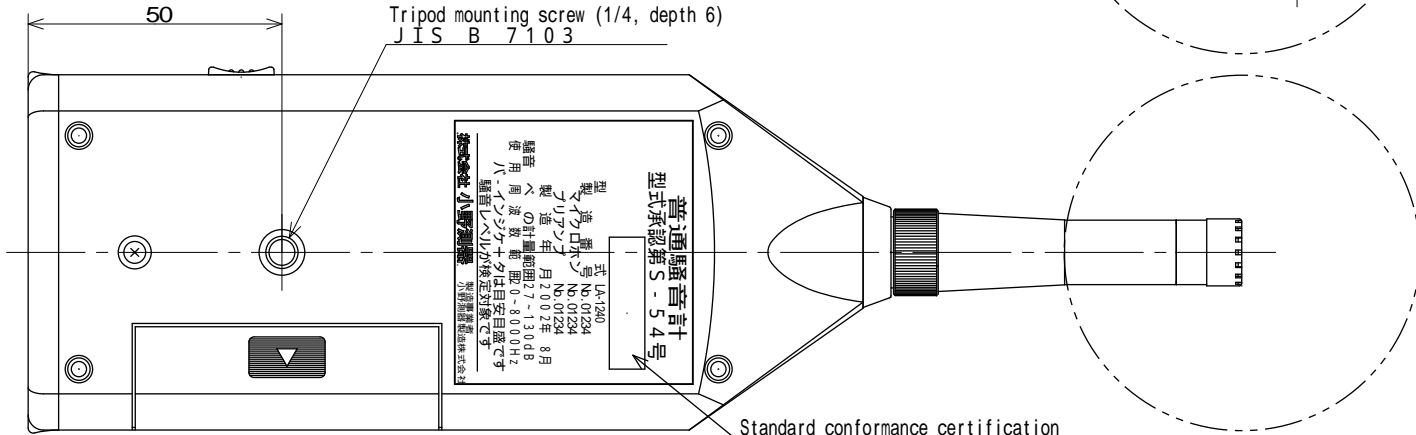

Tripod mounting screw (1/4, depth 6)
JIS B 7103

Standard conformance certification
(Attached plate to certify Japanese standard)

Weight: Approx. 260g (batteries included)
(Unit: mm)

LA-1240
ONO SOKKI